



A Guide To Water Well Casing and Screen Selection

A Note About Roscoe Moss Company

Roscoe Moss Company, publisher of this guide, has been engaged in the development of ground water since the 1890's. Originating as a water well drilling contractor operating in the Southwest, the firm has constructed thousands of wells throughout the United States and in ten foreign countries.

In 1926, Roscoe Moss began the manufacture of water well casing and screens. Emphasis on the development of these products has brought the company to the forefront of specialists in the marketing of these materials.

Completing its uniqueness as a firm engaged in all phases of ground-water development, Roscoe Moss has an active interest in two large California water utilities serving 1.8 million people. Included in their supply sources are over 500 high capacity water wells.

The material contained in this pamphlet is in based on a broad practical knowledge of water well design, construction, operation and maintenance, as well as steel products manufacture. These resources are enhanced by an ongoing systematic research and evaluation program. We are pleased to share the information following, some of which represents proprietary company knowledge and has never before been published.

A Guide To Water Well Casing and Screen Selection

Table of Contents

1.0 INTRODUCTION	4
2.0 METHODS OF WELL CONSTRUCTION	6
2.1 Cable Tool	6
2.2 Rotary	7
3.0 GENERAL CASING AND SCREEN CONSIDERATIONS AND MATERIALS	9
3.1 Strength and Durability	9
3.2 Handling and Maintenance	9
3.3 Economy	10
3.4 Steel	10
3.5 Non-Ferrous Materials.....	10
4.0 MANUFACTURING PROCESSES AND END USE COMPARISONS	11
4.1 Electric Resistance Welded	11
4.2 Seamless	11
4.3 Press Formed	12
4.4 Fabricated	12
4.5 Spiral Weld	12
4.6 Corrosion	13
4.7 Dimensions	13
4.8 Availability	14
4.9 Substandard Pipe	14
5.0 CASING REQUIREMENTS	15
5.1 Diameter	15
5.2 Wall Thickness	16
5.3 Corrosion Resistance	18
5.4 Conductor Casing	20
6.0 WELL SCREEN REQUIREMENT	21
6.1 Aperture Size and Internal Design	21
6.2 Economy	21
6.3 Entrance Velocity	21
6.4 Maintenance and Future Contingencies	22
7.0 SCREEN DESIGNS	23
7.1 Torch Cut Slots	23
7.2 Milled Slots	23
7.3 Wire Wrap	24
7.4 Bridge Slot	25
7.5 Shutter Screen	25

8.0	END CONNECTIONS AND ACCESSORIES	27
8.1	Threaded and Coupled	27
8.2	Plain Ends	27
8.3	Bell and Spigot End	28
8.4	Welding Collars	28
8.5	Stainless Steel to Carbon Steel Connections	28
8.6	Compression Sections	29
8.7	Landing Clamps	29
8.8	Casing Guides	31
8.9	Float Plates	31
8.10	Diameter Reduction	31
8.11	Bottom Plugs	32
9.0	APPENDICES AND TABLES	33
9.1	Appendix I - Well Efficiency	33
9.2	Appendix II - Formation Sampling, Filter Pack & Aperture Size Selection	34
9.3	Appendix III - Analysis of Driving Casing with Cable Tool Equipment	37
9.4	Appendix IV - Water Sampling for Chemical Analysis	39
9.5	Table A - Head Losses Through Pipe	40
9.6	Table B - Physical Characteristics Blank Casing	41
9.7	Table C - Specifications Steel Pipe	43
9.8	Table D - Specifications Steel	45
9.9	Table E - Conversion Table	47

1.0 INTRODUCTION

Water has played a vital role in the advancement of mankind. The earliest traces of civilization reveal that those cultures which flourished were able to employ water sources for domestic, and agricultural purposes. A characteristic of all developed countries today is their ability to use productively the water made available to them.

While ground-water use began in arid and semi-arid regions thousands of years ago, more recently development has occurred in areas with ample surface supplies. This has provided supplemental sources for use by agriculture at the most beneficial time during the growing season and availability during drought conditions. Thus, a world ground-water development industry has grown, focusing attention on water well construction techniques, design and operating methods.

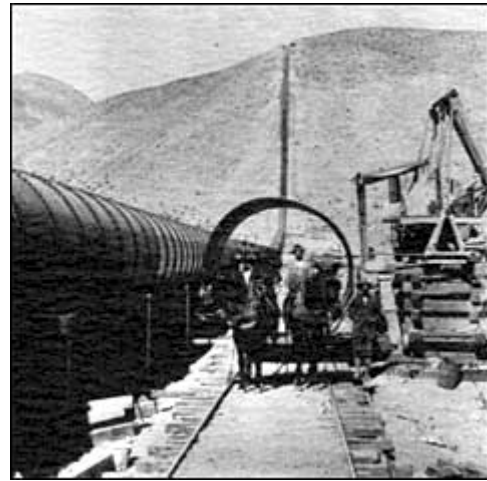

Construction of Los Angeles Aqueduct, 1907-1913.



The scope of the investigation included plotting of a typical geologic cross section through the Pleasant Valley aquifers and a computer analysis and comparison of specific capacities per foot of screen for each of the wells.

Regardless of purpose, almost all water wells must be provided with a means of protecting the borehole and provision made for the entrance of water from surrounding aquifers. While well casing is simply defined as the material that cases or lines a borehole to prevent formation collapse, there are varied interpretations of the meaning of well screen. This is due to the existence of many designs throughout the world. In this guide, screen refers to that structure in a well, which protects the borehole, but allows the entrance of water. In this sense, screen is a filter.

The durability and efficiency* of a well depend to a large degree on its design, construction procedures and selection of casing and well screen. However, casings and screens alone comprise the principal substance of a completed water well.

*An explanation of well efficiency appears in Appendix 1.

While representing a fraction of total investment, they are critical to the productive life of a well and pump. In addition, yield and operating expenses are influenced. The latter has grown more important due to rapidly escalating energy costs.

Another matter attracting increased attention today concerns contamination of ground-water supplies from harmful materials originating at the surface. Protection of a well requires controlling the pollution source. In many cases, the use of sealed casings and more durable materials is helpful.

This pamphlet discusses casing and screen materials in common use in the world today. It also sets forth the factors to be considered in their choice. These factors include methods of well construction and their relationship to well design. While a complete answer to every planning requirement cannot be provided here, the information following may be used as a general guide by those concerned with ground-water development.

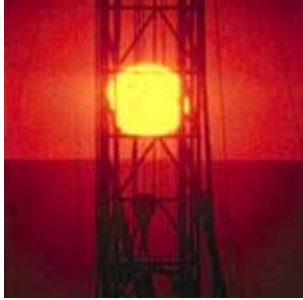

2.0 METHODS OF WELL CONSTRUCTION

2.1 Cable Tool

There are several methods of drilling water wells today. These relate to particular well design and casing and screen requirements. A brief discussion of these techniques is presented below.

Many wells today are being drilled by a method which is centuries old. Although cable tool (percussion) drilling rigs and tools have changed, the basic principles involved in this system have remained the same. The borehole is drilled by the pulverizing action of a reciprocating steel bit suspended from the drilling rig by a wire cable. As the bit strikes the bottom of the hole, the formation is crushed, creating cuttings which are removed by bailing. If the formation is loose and unconsolidated, the casing must be forced in to the hole periodically to prevent caving.



Several procedures are available for completing wells drilled by the cable tool method. If casing is installed as the hole is drilled, it may be perforated by down-the-hole tools, forming a screen opposite the water-producing formations. With most methods of down-the-hole perforating, a small aperture cannot be formed nor can the aperture size be precisely controlled. Consequently, finer-grained aquifers must be avoided. In general practice, the cable tool method lends itself more to drilling coarser, harder formations. In some regions casing is installed to the total depth and a screen telescoped through the casing to the bottom. The casing is then withdrawn partially to expose the screen to the aquifer or aquifers. A variation of this method, permitted under certain drilling conditions, is installation of casing to the top of the aquifer and drilling additional open borehole to accommodate the screen, which is installed by lowering into place. With the advent of rotary drilling methods, these techniques are rarely used.

Down the hole hydraulic lower perforator.

Small diameter wells for domestic purposes, drilled in tight, consolidated formations, are constructed with cable tools or down-the-hole air hammer. These wells often only need a surface conductor casing installed through the unconsolidated overburden. Water is produced from the open hole. In some cases, a protective casing is installed to the depth of the pump.



Screen formed by perforating casing in

Under favorable drilling conditions and where the aquifers are well known, screens in the form of preperforated casings can be installed as the borehole is drilled. Such preperforated casing are normally slotted vertically for greater compressive strength to withstand being driven into place. The driller must be sure that he can carry the screens to the planned depth opposite the aquifers.

2.2 Rotary

During the last 30 years, the use of direct rotary and reverse circulation rotary drilling methods has come to dominate the construction of higher capacity water production wells. Both rotary methods are linked with the gravel envelope well design. With the direct rotary method, a rotating bit under controlled loading is applied to the formation. Water with additives to provide weight and viscosity is pumped down the drill pipe, through the bit, and circulates up the hole carrying the cuttings, which are separated and removed at the surface. Usually the finished borehole is accomplished in two or more stages. A smaller pilot bore is drilled first, then reamed to a diameter 6 to 12 inches greater than that of the casing and screen. The screen is selected and designed according to information gained through analysis of the cuttings* and electric logging. It is then installed with the casing in a continuous operation. Selected gravel is placed in the annular space between the casing and enlarged hole to stabilize the formation and provide a filter against fine sand or silt which might be present.



The reverse circulation rotary method varies from the direct rotary method in three major respects. The circulating fluid flows down the hole and up the drill pipe. While hydrostatic pressure against the formation maintains the wall of the borehole in both systems, usually no additives are mixed with the circulating water. Finally, under reverse circulation procedures, the hole is normally drilled without staging. Selected casings and screens are installed and gravel placed as in the direct rotary method.

Many factors are considered in selection of drilling method and well design. Among them are depth, diameter, hardness or formation, presence of fine-grained aquifers that need a gravel envelope filter, accessibility of site to availability of the quantity of water required for drilling. Rotary drilling construction, particularly reverse rotary, requires large amounts of water. Many factors are considered in selection of drilling method and well design. Among them are depth, diameter, hardness or formation, presence of fine-grained aquifers that need a gravel envelope

filter, accessibility of site to availability of the quantity of water required for drilling. Rotary drilling construction, particularly reverse rotary, requires large amounts of water.

In some areas, gravel envelope wells permit the production of greater quantities of water than non-gravel envelope wells, but this is not always the case. Many high efficiency water wells are being constructed today by the cable tool method.

*See Appendix II.

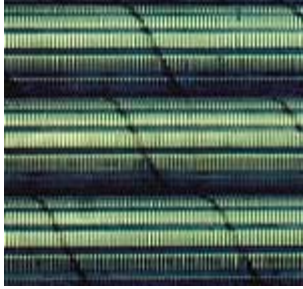

3.0 GENERAL CASING AND SCREEN CONSIDERATIONS AND MATERIALS

3.1 Strength and Durability

Regardless of construction method, water well casings and screens have some common requirements. Strength must be adequate to withstand not only the stresses of installation, but also other forces which may be applied during well completion, development and use. The forces of installation which tend to pull the casing and screen apart must be exceeded by the tensile strength of the material.* The resistance of the casing to collapse (see page 27) must be greater than the external hydrostatic forces calculated.

Radial stresses of the wall of a small diameter hole in a consolidated formation are negligible. However, it is impossible to calculate the load on casings and screens in unconsolidated formations. Unknown are forces from formation sloughing, caving and subsidence, or the sudden downward movement of filter pack material. These stresses can rupture casings and screens.

Another requirement related to strength is durability. Small increases in the wall thickness of ordinary low carbon steel casings not only improve strength, but under most conditions, extend well life, from a corrosion standpoint, by a factor greater than the percentage thickness difference. Corrosive environments may require the use of special corrosion-resistant material.

3.2 Handling and Maintenance

Ease of transport, handling and installation are important considerations. These not only influence cost but are also relevant to the selection of the type of casing and screen field connections.

Casing and screen should be designed to facilitate future rehabilitation including cleaning, incrustation removal, redevelopment and repair. Another consideration is the possibility of future well deepening. Casing and screen diameter as well as type and material selected are influenced by the parameters.

*When casings are driven into place, a more critical and complicated condition occurs which is discussed in Appendix III.

3.3 Economy

Economy plays an important role in the engineering of any ground-water producing installation. Considering water well materials, however, lower cost does not necessarily mean the least durable or efficient. On the other hand, the most expensive do not always produce the best results. Optimum balance between design and price requires a knowledge of those special conditions pertaining to the well and comparison of available products. An example is analysis of the required well life. This is becoming more important, particularly in the case of municipal wells. Inflation, the lack of proper sites, and the difficulty of transporting, setting up and operating water well construction equipment in restricted urban locations, have dictated the use of better well designs, and in many cases more durable materials for extra longevity.

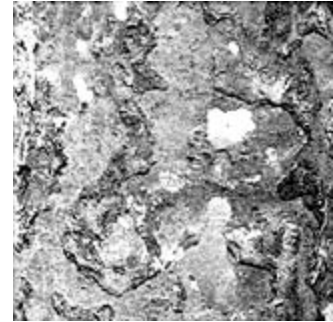

3.4 Steel

By far most common casing and screen material is steel. Steel is easily formed into tubes, the ideal casing and screen configuration. When exposed to the atmosphere, water or soils, steel builds up a protective oxide coating which assures long life under mildly corrosive conditions. Under more extreme conditions, steels with special chemistries or alloys, such as the stainless steel grades, are available for greater life or permanent protection. Steel possesses the high yield and tensile strengths required for water well use. Of particular importance are the characteristics of elasticity and resiliency inherent in steel. Casings and screens may be subjected to underground external forces after installation. Earthquakes or subterranean earth movements tend to displace them. Steel permits absorption of many forces with maintenance of structural integrity. Another important quality of steel is its weldability. This facilitates proper field installation.

3.5 Non-Ferrous Materials

In some areas, non-ferrous materials have been used with some success in wells. The most common are cement, plastic and fiberglass. Concrete casing can be used in some shallow installations, but its weight, difficulty in handling and special connecting-joint requirements, have rendered it impractical for general use.

Plastic has been used successfully in shallow domestic wells up to 8 inches in diameter. Connection, collapsing and tensile strength requirements are relatively modest in such installations. Plastic has not yet been found to be a suitable material for large diameter or deep wells because of cost and strength considerations.

Fiberglass has found use in some areas where waters are known to be corrosive. Again, connecting-joint limitations have restricted its use to shallow and medium depth wells. While mechanical joints designed for this end use have been adequate for installation purposes, they have been known to present difficulties in well rehabilitation. Fiberglass is also costly, particularly for the larger diameter, heavier wall fiberglass tubes required in high production wells.

*See Appendix II.



4.0 MANUFACTURING PROCESSES AND END USE COMPARISONS

Water well use represents a very small percentage of the production of steel tubular products. Practically all steel pipe manufactured worldwide falls into two categories:

1. Transmission (line) pipe for the conveyance of water, oil, or gas.
2. Oil country tubular goods such as heavy wall tubing and drill pipe.

It is useful to review the major manufacturing processes of these materials and relate them to their primary purposes, as well as their potential for use as water well casing

4.1 Electric Resistance Welded

Generally transmission pipe of diameters from 4 to 16 inches is produced by the electric resistance weld (ERW) process. First raw material in coil form (skelp) is unrolled and flattened. The skelp then moves through a series of forming rolls which stage by stage shape it into a cylinder. The seam is welded as it passes beneath rotating electrodes. Resistance encountered by the current at the seam edge heats the metal to a plastic state. Simultaneously pressure is applied, forging the edges together. The pipe then travels through a series of finishing rolls. These stages reduce the diameter slightly, assuring proper size and roundness. Since resistance-welded pipe use, it is manufactured in approximate 40-foot lengths for convenient field assembly.

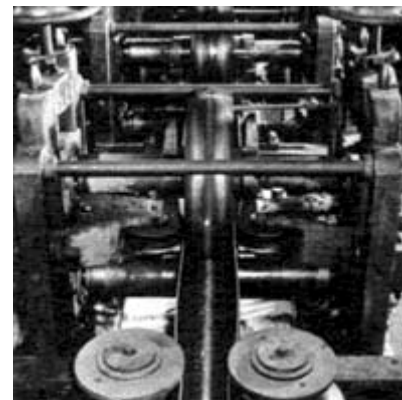

Electric resistance welded pipe forming

4.2 Seamless

Oil country tubular goods, such as high pressure tubing and drill pipe, require thicknesses and chemistries which are difficult to weld by ordinary procedures. These products and other special purpose pipe and tubing in diameters 20 inches and smaller are usually manufactured by the seamless process. A billet of steel is heated to a plastic state and pierced by a spear or lance. The hollow billet is then gradually elongated as it is shaped over mandrils and sized by rollers until pipe is produced. For water well applications seamless pipe has no inherent advantage over welded pipe, and its higher cost is not justified. Furthermore, wall thickness uniformity is not as consistent as pipe or casing produced by other methods of manufacture.

4.3 Press Formed

A substantial portion of transmission pipe 18 inches in diameter and larger is manufactured by the press forming process. This method is a three stage operation.

1. In the first stage the edges of a flat steel plate are curved upward.
2. The plate is then pressed by dies into the shape of a "U".
3. In the final stage a third press closed the "U" to form a cylinder.

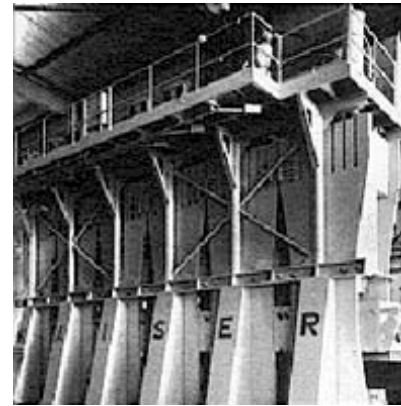

Final stage press forming

The seam is then welded by the submerged arc electric weld (SAW) process. SAW welding required the use of a bare wire electrode and a granular flux. Contact of the electrode and the seam to be welded creates an electric arc. As a welding head traverses the seam, wire and flux are continuously added. The function of flux is to shield the molten weld from atmospheric contamination and add alloys to the weld deposit. This process allows the weld puddle to be molten long enough to purge impurities.

SAW welds are strong, ductile and uniform. Their mechanical properties are equal to or superior to those of the base metal.

4.4 Fabricated

Generally used for production of large diameter pipe for special end uses, this process is non-continuous and multistaged. Flat sheets or plates are first squared and sheared to the proper diameter requirements. In the second stage, longitudinal edges are preformed to the required pipe curvature. The steel is then driven between rolls, bending it into a cylinder. Seam welding is performed by the SAW process. Longer lengths, when required, are manufactured by welding together the necessary number of cylinders.

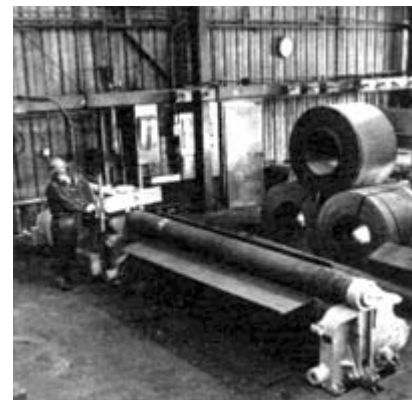

Fabricated pipe cylinder forming

4.5 Spiral Weld

A newer pipe manufacturing technology involves fabricating a spiral seam tube. Skelp is first flattened and then formed into a cylinder between rolls or a circular-shaped cage or shoe. The seam is welded at the first point of strip contact. Most spiral tubes today are welded from both the inside and outside, assuring full weld penetration. The spiral system is a continuous operation and individual lengths are cut downstream of the producing equipment.



Spiral cylinder forming operation

The spiral process offers special advantages. Wall thickness varies according to the thickness of raw material. Since skelp adheres to very close tolerances, pipe manufactured by the spiral and electric resistance weld processes is more uniform and accurate in wall thickness than pipe produced by the seamless and press forming methods. Spiral pipe mills are flexible, enabling the manufacture of pipe from many grades of steel and non-ferrous weldable metals. Non-scheduled

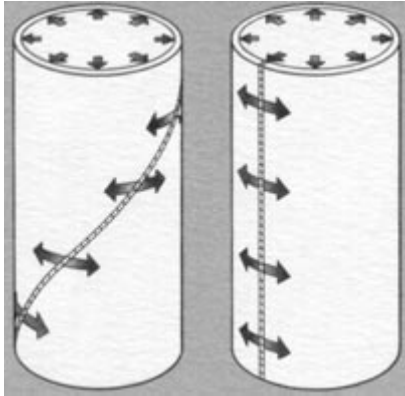

Spiral and straight seam stresses

diameters and thicknesses can be economically produced for water well installations where required. Another virtue of this system of pipe manufacturing is high product roundness and straightness. Also beneficial is the greater strength of submerged arc electric welded seams. This results from the reinforcement of the weld, and the fact that hoop stresses in a spiral seam tube are less than those in a straight seam tube due to the "bandage" effect, and distributed forces.

Inherent in the spiral method is the ability to form high strength, heavy wall, large diameter pipes currently required in the petroleum and gas industries. For that reason, most recently built facilities producing such products utilize this process.

Much water well casing used worldwide is designed and manufactured in accordance with transmission pipe specifications and requirements. Therefore, it is important to understand the different end uses and problems which may result from incorrect selection.

4.6 Corrosion

Raw material used in the manufacture of line pipe does not normally contain any added elements to give protection against corrosion. It is easier and more effective to provide safeguards in the form of protective coatings. Insulating coatings must be completely perfect, since a random bare spot corrodes at a greater rate than if the pipe were completely unprotected. The use of protective coatings on water well casing is ineffective or harmful due to abrasion incurred during handling, installing, perforating and use. Coating of the field connection is impossible to apply properly. Consequently, the corrosion resistance of well casing must be built into the steel itself.

4.7 Dimensions

Seamless, ERW and press formed pipe diameters are controlled externally. Accordingly, nominal diameters are measured by the outside diameters (O.D.), and the inside diameters (I.D.) varies with the wall thickness of the pipe. For instance, 16 inch O.D. pipe .3125 inch thick would have an inside diameter of only 15.375 inches. Casing diameter is generally selected according to pump size. Therefore, it is often possible to substitute an I.D. size for the next larger O.D. size; for example, 16 inch I.D. instead of 18 inch O.D. Also, since tools required for the construction and repair of water wells work through the interior of the casing, it is appropriate to standardize on inside diameter rather than on outside diameter.

4.8 Availability

Transmission line pipe is ordinarily stocked in double random (38-45 ft) lengths. Occasionally, single random (16-22 ft) joints are produced. Incompatibility with the handling capabilities of any particular drilling rig can result in additional cost and installation lost time.

Since diameter changeovers in seamless, ERW and press formed manufacturing processes are relatively time consuming and expensive, efficiency requires lengthy runs of a given diameter. Thus, availability to a well drilling contractor depends on existing stocks. Moreover, integrated steel mills usually do not manufacture wall thicknesses less than .1875 inch in 8 inch and 10 inch diameters or less than .250 inch in diameters of 12 inches and larger.

4.9 Substandard Pipe

Line pipe produced to API and other specifications must be subjected to various tests during and following manufacture. In recent years, some pipe which has failed these required tests has been sold as water well casing. Among the names applied to this product are: reject, substandard, limited service and structural pipe. Since quality often means the difference between success and failure, it is to the users' interest to be aware of the potential danger. Since substandard pipe is distributed at discounted prices, the manufacturer disclaims responsibility for this inferior material.

A large proportion of rejected pipe has failed tests to determine weld soundness. Under these circumstances, the stresses of installation or perforating may cause a seam to split, allowing formation material to enter the well.

Pipe may be rejected for reasons other than faulty welding. Variations in diameter or non-uniform wall thickness are frequently cited. It is to the interest of those concerned to consider the relationship of quality and responsibility to the ultimate cost.



Substandard pipe manufactured from laminated steel has substantially reduced collapsing strength.



5.0 CASING REQUIREMENTS

This section deals with the factors which should be evaluated in the casing selection, including elements relevant to the casing and screen relationship.

5.1 Diameter

Diameter of the upper pump housing casing must provide sufficient clearance between the column pipe and casing to permit installation of a sounding tube or air line to measure depth to water. Extra clearance should be allowed for free operation of shaft driven pumps and the electric cable for submersible pumps. No well is exactly straight and operation will be unsatisfactory if there is misalignment. Additionally, consideration should be given to the possibility of corrosion product buildup which may lock the bowl to the casing. Consequently, pump housing casing should have a minimum diameter at least two inches greater than the nominal diameter of the most efficient pump required for the desired yield.

PUMP HOUSING DIAMETER SELECTION CHART			
Nominal Bowl Diameter (in.)	Operating Pump Speed (RPM)	Yield (gpm)	Minimum Casing I.D. (inch.)
8	3500	200-1200	10
	1800	100-600	
	1200	160-400	
10	1800	200-1500	12
	1200	370-670	
12	1800	400-2300	14
	1200	250-1500	
14	1800	1000-4500	16
	1200	800-3500	
16	1800	2000-5200	18
	1200	1300-3400	
18	1800	3200-5400	20
	1200	2200-4000	
	900	2800-3000	
20	1200	3100-5500	24
	900	2300-3600	
22	1200	7500	24
	900	5600	

For submersible pumps increase minimum I.D. 2 inches.
For pump settings below 400 feet increase minimum I.D. 2 inches.

The chart above serves as a guideline for specification of pump housing diameter according to production.

While it is true that increasing well screen diameter does not have much effect on production, there are strong reasons for specifying identical casing and screen diameters, with the exceptions of telescoped screen installations and under-reamed gravel envelope well design. Equal internal

diameters facilitate well development and redevelopment processes. The possibility of damage due to dropping a pump or tools is minimized. Maintaining identical diameters prevents the possibility of excessive head loss through a restricted tube. Finally, it must be remembered that wells smaller than six inch diameter are practically impossible to repair and larger diameters facilitate later deepening if required.

In wells deeper than 1,200 feet, a reduction of four inches in screen diameter can be practical. This is generally limited to high capacity wells where the screen diameter is a minimum of 12 inches. The saving in screen and borehole costs may offset other considerations. This reduction normally begins at the bottom of the pump housing case.

5.2 Wall Thickness

A more difficult dimensional selection of well casing is wall thickness. As mentioned earlier, certain stresses such as the external hydrostatic force (draw-down) can be calculated, but others cannot. Fortunately, many years field experience under varied conditions provides useful information and guidance.

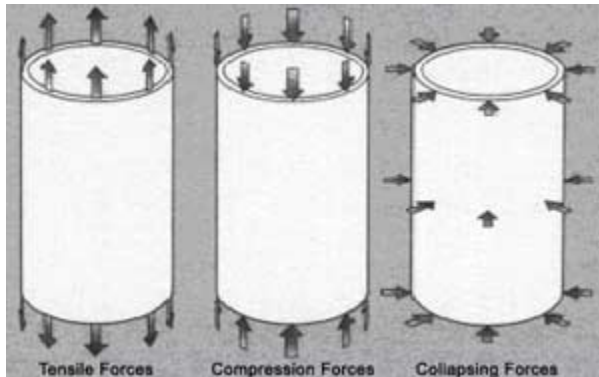

The tensile (ultimate) strength of a metal is defined as the load in the direction of pulling it apart which is required to break it. Compression or crushing strength is the load in the opposite direction (pushing it together) required to deform it. This value is equivalent to the yield strength.

Steel strengths vary according to chemistry and manufacturing techniques. Pipe tensile and compression strengths are directly related to the

tensile and yield strengths of the parent material as well as its dimensions. Generally, wall thickness is the critical factor to consider.

The resistance of steel tubes to collapse under hydrostatic or similar squeezing forces is determined by outside diameter, wall thickness and ellipticity (out of roundness). In addition to these dimensional parameters, collapsing strength is influenced by some of the physical qualities of the material. These are Young's modulus which is a measure of material stiffness, yield strength and Poisson's ration. While several agencies, including the American Petroleum Institute and the national Aeronautics and Space Administration, have developed formulas relating these parameters to collapsing strength, the values shown in Table B, page 70,, are based upon Timoshenko's formula using 1% as a value of ellipticity and 35,000 psi as the steel yield point. Use of this formula provides conservative values which are justified, considering the critical nature of collapsing strength in water wells. An analysis of Timoshenko's formula shows that casing continuously deforms with increasing pressure until the critical pressure is reached. The casing is considered to be collapsed once deformation continues without additional pressure.

The three graphs shown above illustrate some very important points. Plotted are the effects of yield strength, wall thickness and ellipticity on collapsing strength, using 10.750 inch O.D. casing as an example. It can be seen that the dimensional parameters (wall thickness and ellipticity) are more closely related to collapsing strength than the physical parameter (yield strength). Use of higher strength steels does produce improvement in collapsing strength, but is more significant with respect to compression and tensile strength.

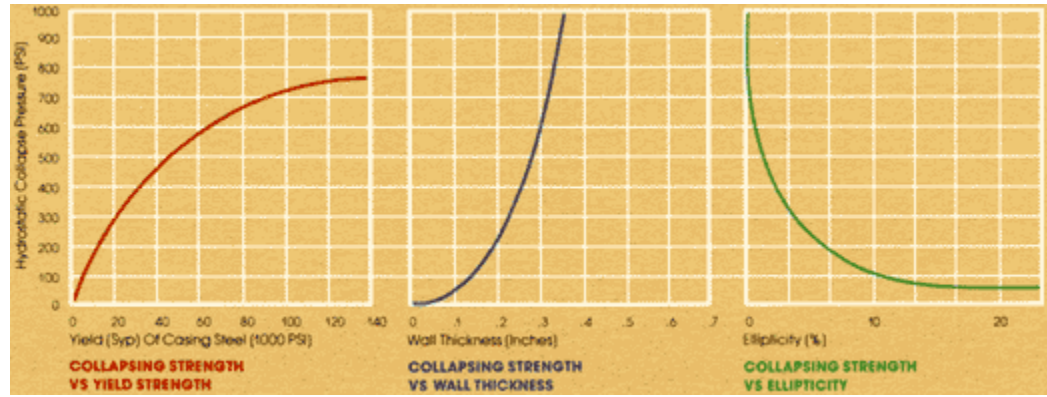

and ellipticity on collapsing strength, using 10.750 inch O.D. casing as an example. It can be seen that the dimensional parameters (wall thickness and ellipticity) are more closely related to collapsing strength than the physical parameter (yield strength). Use of higher strength steels does produce improvement in collapsing strength, but is more significant with respect to compression and tensile strength.

The collapsing strength of steel is proportional to the cube of its wall thickness. Therefore, a small increase in thickness provides a substantial increase in collapsing strength. Conversely a small decrease in thickness results in a substantial decrease in collapsing strength. The importance of pipe roundness to strength is also obvious from the graph on ellipticity.

It is apparent from the forging that used or damaged pipe should never be installed in a water well. The fact should be kept in mind that unless there is a subsidence problem (see page 52) most structural failures in wells occur due to collapsing forces.

The following chart provides a guideline for selection of wall thickness according to casing diameter and well depth. It is based on experience under varied conditions as well as mathematical analysis. Also taken into consideration is the economic factor. Since the cost of deeper wells is greater, use of stronger, more durable material is justified to assure adequate return on the larger investment. Also, while no specific data exists, experience has shown that stresses imposed on casings and screens usually increase with well depth.

Casing Depth (Feet)	Casing Diameter (Inches)										
	6	8	10	12	14	16	18	20	22	24	30
0-100	12	12	12	10	10	8	8	8	8	8	3/16
100-200	12	12	10	8	8	8	3/16	3/16	3/16	3/16	1/4
200-300	10	10	8	8	8	3/16	3/16	3/16	1/4	1/4	1/4
300-400	10	8	8	3/16	3/16	3/16	1/4	1/4	1/4	1/4	5/16
400-600	10	8	3/16	3/16	3/16	1/4	1/4	1/4	5/16	5/16	5/16
600-800	3/16	3/16	3/16	3/16	1/4	1/4	1/4	5/16	5/16	3/8	3/8
800+	3/16	3/16	3/16	1/4	1/4	1/4	5/16	5/16	3/8	3/8	7/16

SUGGESTED MINIMUM THICKNESS FOR STEEL WATER WELL CASING
 Diameter Thickness in U.S. Standard Gauge
 Diameter Thickness in Inches

5.3 Corrosion Resistance

As a component of well design, the effects of corrosion under the anticipated operating conditions should be examined. Metallic corrosion is a complex subject, more thoroughly discussed in the Roscoe Moss publication "Fundamentals of Metallic Corrosion in Fresh Water", by J.R. Rossum. Some generalizations are made here which may be helpful. First, well casings and screens are subject to different types and degrees of attack according to their location in the well. Since many ground waters are saturated with calcium carbonate, the screen section will tend to encrust rather than corrode, which promotes longevity but frequently requires periodic removal of buildups to restore production. In most wells the greatest corrosion attack occurs in and just above the "splash zone" between the static water level and pumping level. The casing is exposed to a humid atmosphere or an alternate wetting and drying condition which accelerates attack on steel. The pump column is similarly affected.

With respect to well waters themselves, it is generally accepted that the presence of bicarbonate retards corrosion, sulfate and nitrate are neutral and chloride accelerates corrosion. Concentrations of carbon dioxide of over 50 mg/liter are usually corrosive. Water containing hydrogen sulphide should be checked for the presence of sulphate-reducing bacteria which are highly detrimental to well screens. Acidic water may be severely corrosive, but the corrosion is usually uniform, rather than pitting. Consequently, well life may be greater than normally expected.

It is unfortunate that no one has developed a method of determining the life of material given the constituents of the water. Again, the best guide is experience. Throughout the United States, and in most regions of the world, there are ample well histories giving clear directions. There is no condition, when potable waters are produced, where adequate well life cannot be obtained through the use of proper well design and material selection.

Required well life depends upon a host of economic considerations. If one designs a municipal well for 50 or more years operation, the use of stainless steel material, whose corrosion rate is negligible in potable waters, is mandated. In most areas of the United States and elsewhere where waters are generally alkaline, 40-year life is non uncommon. Generally, 30-year life is a reasonable expectation.

With respect to steel casing as noted, greater than average corrosion occurs in the most humid or alternating wet and dry zone. This is a form of atmospheric condition, and the use of heavier wall materials extends life considerably. Doubling wall thickness should extend life four or more times. Increasing wall thickness, however, has not proven to be much help with severely corrosive waters.

The addition of copper to steel so that its content reaches a minimum of .20%, increases its atmospheric corrosion resistance by approximately two times. Specification of this quality material is shown as an alternative in all standard ASTM specifications for structural grade steels. Copper-bearing steel has been used as casing material in the Southwestern United States for over 90 years. Culvert steel is also copper-bearing. A further encouragement to the use of copper-bearing steel is that it results in an increase in casing cost of only about 20% and a percentage increase in total job cost much less than that.

High tensile, low alloy (HTLA) steels have been in general use for many years. They are about 40% stronger than regular carbon steel. Atmospheric corrosion resistance of these materials in the corrosion-resistant grades is four to six times that of carbon steel and two to three times that of copper-bearing steel. There is also some evidence to support the view that they offer greater longevity in the fully submerged area. However, where conditions are severely corrosive and carbon steels do not endure for at least ten years, neither copper-bearing steels nor HTLA steels should be used.

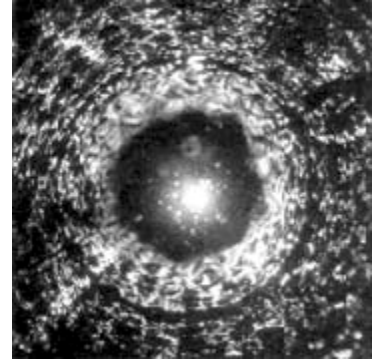

One of the advantages of most HTLA steels is that their high strength is achieved through use of alloying elements rather than additional carbon and manganese. If high strength line pipe is considered for use, the following evaluation should be made: divide the manganese percentage by six and add it to the carbon percentage. If the sum exceeds 0.50%, problems may be encountered in field welding.

Regrettably, there is a substantial difference in cost as well as durability between HTLA steels and the next most corrosion-resistant category, stainless alloys. Type 304 stainless steel (18% chromium, 8% nickel) has been found to offer complete protection in any potable water environment. This steel is also immune to acids used to remove encrustations. While frequently used in water wells, type 304 stainless probably represents overdesign and unnecessary extra cost, since grades containing lower percentages of expensive chromium and nickel do just as well in similar environments.

For salt water wells (chloride concentrations greater than 500 mg/liter) the conventional selection is type 316 stainless steel. In most cases, type 304 is adequate, but has a tendency to pit.

Under conditions where selection of stainless steel is indicated, non-ferrous materials may be considered, particularly in shallow, smaller diameter wells. Careful consideration should be made, however, of the mechanical and other limitations of these materials.

As mentioned earlier, conventional pipeline coatings are not suitable for water well casings or screens. An exception, galvanizing, continues to protect a bare spot or "holiday". Under acidic conditions, however, galvanizing does not offer sufficient additional well life to justify its cost. As an estimate, the 1081 cost of galvanizing approximates 15¢ per lb. Of the galvanized pipe weight.

Cathodic protection of water wells has been field tested, but has not proven practical. The systems are expensive and require maintenance. More importantly, it is not feasible to protect the interior of any pipe structure by cathodic protection. Cathodic protection may be considered, however, for salt water production wells.

5.4 Conductor Casing

Many wells require, for construction and occasionally protective reasons, the installation of a surface or conductor casing. Such casings range from 20 to 50 feet in length although more may be required to reach an impervious stratum. Usually surface casings for gravel envelope wells are 6 to 12 inches larger in diameter than the upper casing and approximately four inches larger for non-gravel envelope wells. Wall thicknesses range from .1875 inch to .3750 inch depending upon depth and diameter. The annular space between the casings may be grouted as well as the annular space between the conductor casing and its borehole.

Surface casing prevents the direct infiltration of polluted surface waters between the casing and borehole and stabilized the upper formations, which are usually unconsolidated, during drilling, completion and use.



*Above right:
Cementing conductor casing-positive
placement capped casing method.*

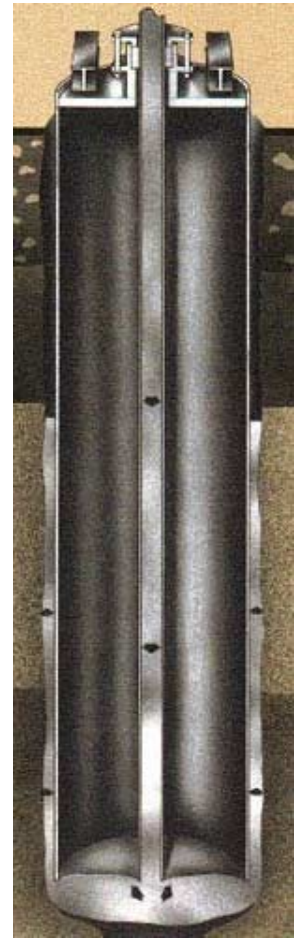

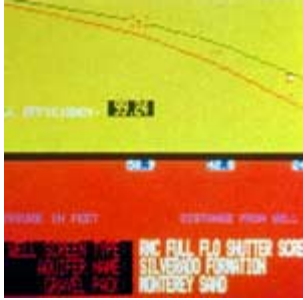

6.0 WELL SCREEN REQUIREMENT

6.1 Aperture Size and Internal Design

Over the years, many different types of screens have been developed to meet the varied requirements of water wells. Common sense suggests that there is no single type best for all conditions. Well screen types have different attributes and characteristics and may be equal in some respects, but unequal in others. To assist in evaluation, the following general requirements are set forth:

The well screen should have the largest possible aperture size consistent with retaining the filter pack in a gravel envelope well, or formation material in non-gravel envelope wells.

The internal configuration of the screen should facilitate well development and redevelopment through accommodation of the most effective mechanical methods available, such as tight swabbing.

6.2 Economy

Economy is not only a general consideration, but a special one, if cost dictates the use of less screen or screening of intervals only in gravel envelope wells. These practices have had unfortunate results in many cases. Often even if the best sampling procedures are followed and electric logging performed and interpreted, selective screening can result in inadvertent blanking off of productive aquifers. Another important consideration is the bridging tendency of gravel at the top of any screen section. It is difficult and sometimes impossible to consolidate gravel behind blank casing. Possible outcomes include sand pumping or sealing off of water through sloughing of impervious material against the aquifers. This does not apply to the bottom of the well where a 10 to 20 foot section of blank casing should be installed to provide a basin for sediment material.

6.3 Entrance Velocity

Proper screen design minimizes frictional head losses associated with the entrance of water into the well. This point has been overemphasized in the past, with virtues claimed for screens with the highest area of opening (lowest entrance velocity) which have not been confirmed by field data. Extensive research, including mathematical analysis, review of practical experience and extensive model testing, has

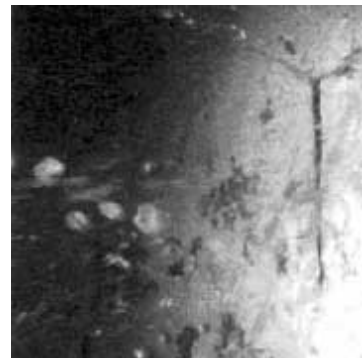

Plugged vertical milled slot screen with greatly reduced effective area of opening.

established that entrance velocities up to 3.5 feet per second result in minimal head losses. An important factor in determining actual entrance velocity, however, is the "effective area of opening", which may be less than the measured opening due to plugging or invasion of fine material. This is usually the result of poor gravel pack and/or slot size selection. The screen opening should be designed to minimize this possibility.

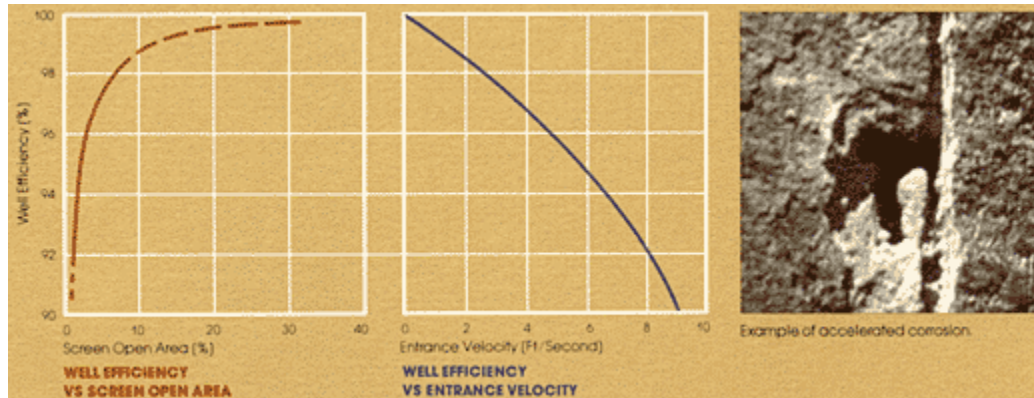

While there have also been many statements concerning the role of entrance velocity through a screen with respect to corrosion and encrustation, the body of field and theoretical evidence does not prove any relationship with respect to the usual range of velocities through commonly used screens.

Actually, velocities from one to five feet per second are considered beneficial in pipelines. Higher velocities often cause a combination of corrosion and erosion which may be very severe. This condition occurs in wells where most screen openings have been encrusted, leaving the water to be produced from a sporadic few. In addition to losses in production and well efficiency, high entrance velocities through these perforations can cause rapid enlargement and frequent failure. Proper screen configuration and sufficient area of opening mitigate this problem.

6.4 Maintenance and Future Contingencies

The screen should be designed to be as maintenance-free as possible. However, maintenance is a function not only of screen geometry, but also of well design and material selection. The screen should permit deepening or repair if required.

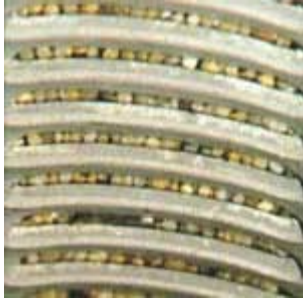

7.0 SCREEN DESIGN

7.1 Torch Cut Slots

With the preceding section in mind, analysis may be made of the types of screens in common use. The first considered represents, under any circumstances, and undesirable choice. This is casing with vertical slots perforated by a cutting torch. Fortunately this practice has fallen into disfavor, and is infrequently used today. The only reason for inclusion of such material in a water well is lack of an alternative. The disadvantages of torch cut slots are low area of opening, high corrosion at the ragged torch cut edges, slag, irregular uncontrolled openings, weakness particularly in collapsing strength, and a great tendency to clog. Even low cost is not an advantage of this material, since torch cutting with oxygen-acetylene gas is a slow process.

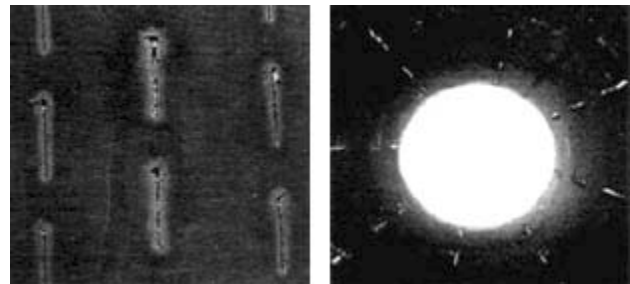

7.2 Milled Slots

Another vertically slotted screen is manufactured from casing by milling openings with axially oriented cutters. This product is designed for use in oil wells where fluid production is very low. Its disadvantages include clogging due to the parallel surfaces within the opening. Since slot clogging is directly related to wall thickness, thicker material encourages greater plugging. Some vertical mill slotted casings are machined with an undercut to reduce this tendency. A second drawback is low area of opening, although this can be overcome at higher cost by increasing the number of slots. Collapsing strength of vertically slotted casings, however, is substantially reduced when the number of openings is increased.

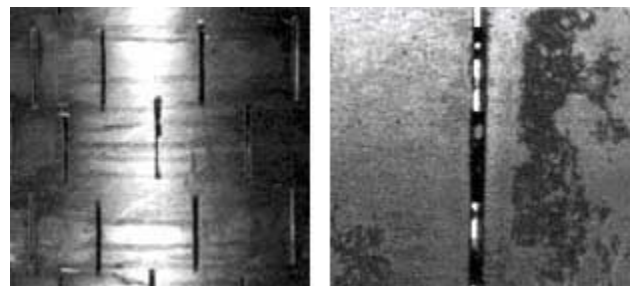

Field experience has proved that development is generally slower in wells screened with milled slot casings. Another aspect of vertical slots compared with horizontal openings is that sand and gravel control is less positive. A smaller aperture and/or larger gravel must be specified. The filter pack should be relatively coarse, with at least 90% retention, rather than the conventional 65 to 80%.

The chief positive characteristics of milled slot casings are low cost, uniform openings and availability in a fairly wide range of apertures and patterns.

7.3 Wire Wrap

One well-known well screen is manufactured by wrapping a wire around longitudinal rods. The wire is welded to the rods by resistance welding producing a cage-shaped cylindrical configuration. This type of screen, commonly known as wire-wrap or continuous slot, is usually manufactured from type 304 stainless steel, galvanized steel and carbon steel.

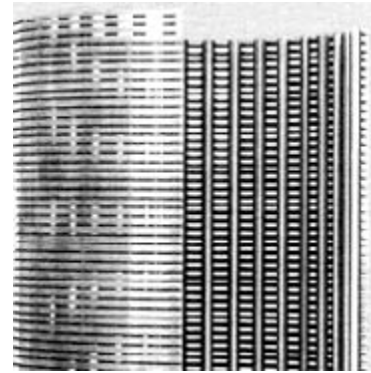

The continuous slot design originated in the early part of this century to overcome the problems of ground-water development from distinctive aquifers associated with the North Central United States. These aquifers were generated from rock picked up, broken, and pulverized by advancing glaciers during the Ice Ages. While glacial till is not well sorted, occasionally thin layers of fine-grained, uniform sands were washed from the original deposits. Such materials are high yielding water producing formations. Prior to the advent of rotary well construction and the gravel envelope well design, it was difficult to produce the full capacity of sand free water from these aquifers. A well design incorporating wire-wrap screen was developed to meet these conditions, and proved successful.

The characteristics of wire-wrap screen are well suited for its original purpose. This design offers the highest surface area of opening of any screen. Consequently, with very small aperture sized (.005 in. to .035 in.) necessary to control fine sands from thin aquifers without a gravel envelope, sufficient area of opening is still available to minimize frictional head losses through the screen. However, under such circumstances, stainless steel must be used since enlargement of openings result in sand pumping. The manufacturing process lends itself to close tolerances required for very fine aperture sized and the V-shaped slot configuration reduces clogging.

Careful consideration must be made of the use of wire-wrap screen in situations or under conditions for which it was not originally designed. It is generally more costly than other types without necessarily providing higher production, better efficiency or greater durability. Screen of this design, including most higher cost, heavy duty versions with bigger rods, wire or both, has lower collapsing strength than other screen types and usually lower than the well casing it is installed with. Special care should be taken in installation.

The configuration of wire-wrap screen makes it difficult to swab, a simple and very effective method of well development, redevelopment and cleaning. This is because the internal surface of the screen is not a smooth circle due to the cross sections of the vertical rods. Close fitting swabs cannot be employed effectively because water bypasses through the annulus between the rods instead of surging in and out of the formation and filter pack. Development with air or high velocity jetting is not as effective a development method, especially in gravel envelope wells. For similar reasons cleaning and removal of encrustations is more difficult, requiring acidizing rather than removal by mechanical methods.

Wire-wrap screens are also more difficult or impossible to repair or restore to their original shape and structural integrity. Extra caution must be exercised using down-the-hole tools.

Finally, the high area of opening, which may be an asset under certain conditions, acts adversely in the carbon steel version. The surface area exposed to corrosion is in the order of three times that of other types of screens. This results in faster loss of weight and strength.

Since wire-wrap screen was originally developed for use in non-gravel envelope wells, its use in gravel envelope wells must take into consideration the requirements of that design for success. Avoid the practice of selective screening for reasons mentioned earlier. Do not use too small a screen aperture size. With a properly designed gravel envelope well there is seldom any condition requiring an aperture size less than .040 inches. However, in this regard, it is important to note that while the V-shaped orifice of continuous slot screen reduces clogging it does not encourage stabilization of the gravel envelope particles. The recommended aperture size is that which will retain 90% of the filter pack. This results in a smaller aperture size than is possible with some other screen designs.

A less expensive wire-wrap screen fabricated from round galvanized steel wire is available. This wire shape encourages plugging through the forming of particles in the narrow orifice.

7.4 Bridge Slot

Another well screen produced in the United States and overseas is referred to as "bridge slot". This screen is manufactured on a press from flat sheets or plates. The slot opening is usually vertical and provides two orifices, longitudinally aligned to the axis. The perforated steel sheets or plates are then rolled into cylinders and the seam welded. Normally five foot sections of bridge slot screen are welded together into longer lengths suitable for field installation.

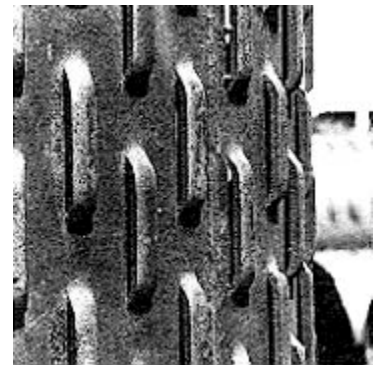

Bridge slot screen is usually installed in gravel envelope wells. Its chief advantages are reasonably high area of opening and minimum frictional head losses at relatively low cost. One important disadvantage is low collapsing strength due to the large number of vertically oriented slots. The manufacturing process is limited with respect to wall thickness and .250 inch is the maximum generally available. Since gravel control is more difficult with any vertical opening as compared to a horizontal opening, a smaller aperture size relative to the pack material should be selected.

7.5 Shutter Screen

One type of screen designed many years ago for use in gravel envelope wells has enjoyed considerable success. Shutter screen was originally manufactured by punch-formed downward facing louver apertures into short lengths of pipe, then welding them together forming sections up to 20 feet long. A more modern method has been developed which permits manufacture from tubes up to 50 feet in length. This process incorporates the use of an internal mandrel which perforates the shutter against external die blocks.

Shutter screen is manufactured in a variety of patterns with various surface percentage area of openings. This flexibility permits designing to meet real conditions and eliminates unnecessary cost.

One of the major advantages of shutter screen is that it has higher collapsing strength (up to 60%) than blank casing of the same wall thickness. This is due to the corrugating effect of the louver-shaped openings.

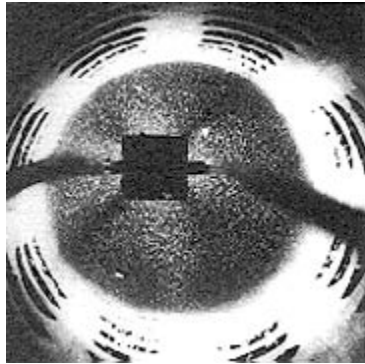

Surprisingly, this strength increases as the percentage areas of opening found in commercially available shutter screen increases. Resistance to collapse does not vary according to aperture size, as in the case of wire-wrap screen.



Three shutter screen patterns

Another important advantage of shutter screen is that tight swabbing can be employed to develop and redevelop wells without risk. This is due to high mechanical strength and a full circular cylinder interior. For the same reason, wells can be repaired and deepened more easily.

Shutter screens are available which afford much lower entrance velocities than required, minimizing head losses. The downward facing louver aperture is particularly suited for gravel envelope wells, and offers special advantages over other opening configurations. Use of down-the-hole cameras, model studies and years of experience confirm that the louver-shaped opening resists clogging as well as, or better than, any other type of screen. Its shape is the same for any wall thickness material. Better gravel control during installation, development and operation is characteristic of shutter screen because of the hood shaped, downward facing orifice. Tolerance of filter pack range is enhanced. Many wells have been successfully completed with greater than 80% of the pack capable of passing through the openings. While the recommended relationship is 35% to 20% passing, this latitude provides protection against variations in the gravel envelope due to segregation or other reasons.

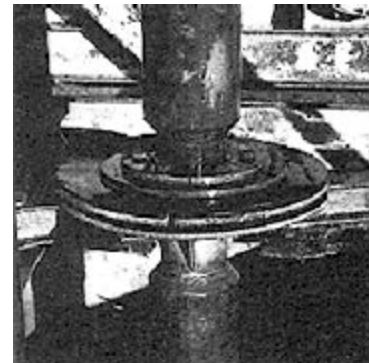

Rotary swab

Well screen is an important component of well design. It must be realized that it is not an answer to all well problems. In a gravel envelope well, it is the gravel that filters the formation material and not the screen. The screen simply retains the gravel pack. Screen selection must be based not only on theoretical considerations, but on a practical relationship to the design and construction of an efficient, durable installation. The best screen design cannot automatically correct incompletely installed gravel or well development. Screen can only facilitate the construction of an efficient well and help assure its satisfactory operation.

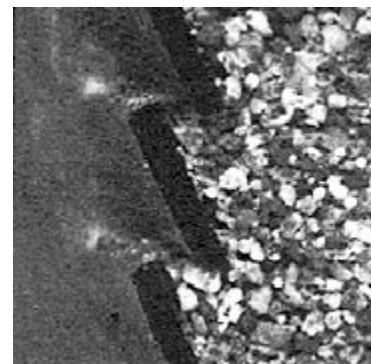



8.0 END CONNECTIONS AND ACCESSORIES

No discussion of water well casings and screens can be considered complete without giving proper attention to the connections through which they are joined in the field. The tensile strength of any column is limited by the strength of the connections between its components. Observation of well failures shows that most involve casing or screen rupture, collapse or deformation. Frequently the problem originates in the connecting joints.

In addition to mechanical strength requirements, the following factors should be considered in connecting joint design: smoothness of internal wall, minimization of external diameter, alignment, ease of installation, and economy.

The four major types of connections used in the water well industry are threaded and coupled joints, joints with square or beveled plain cut ends, bell and spigot joints for lap welding and joints with welding collar for lap welding.

8.1 Threaded and Coupled

Threaded and coupled connections are commonly employed in four inch and smaller diameter wells where they provide relatively inexpensive, fast and convenient connections. Strength requirements in such domestic low production wells are not critical. In larger diameter the cost of threaded and coupled joints increases, and they are not generally available larger than 12 inches.



8.2 Plain Ends

Casing and screen joints prepared with square ends for welding are generally satisfactory up to .1875 inch wall thickness. With heavier wall thicknesses the ends should be beveled to facilitate weld penetration, leaving approximately .125 inch flat. Advantages of these connections are economy and smoothness of the external diameter, which minimizes tendency of gravel to bridge in gravel envelope wells. Disadvantages lie in greater assembly time and the difficulty of properly welding casing in the vertical position. A further problem occurs if removal and reassembly is required. The connection must be cut with a torch as withdrawn, and the joint prepared for proper reassembly by machining, if possible, a time-consuming and expensive process.

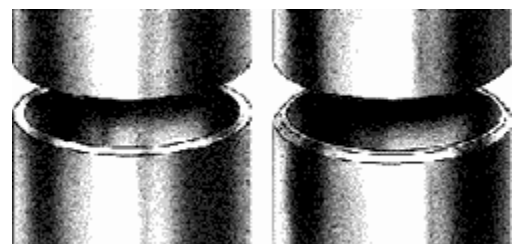

8.3 Bell and Spigot End

Use of bell and spigot joints overcomes a number of problems inherent in plain ended or threaded and coupled joints. A downhill fillet (lap) weld is used to connect the casing and screen sections. Lap welds are easier to make in the vertical position than horizontal butt welds. These joints are also very economical. Their chief disadvantage concerns proper alignment which requires more installation time.

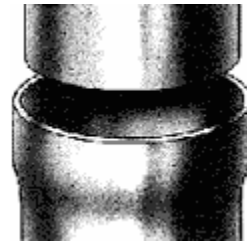

8.4 Welding Collars

Another lap weld connection type that best meets all requirements for six inch and larger casing and screen is the welding collar. Welding collars are factory installed on one end of the joint. Width of the collar ranges from two to six inches with the casing end extending approximately midway through the length of the collar. A properly made welding collar connection is as strong or stronger than the casing. API threaded and coupled joint strength by comparison is less than 70% of casing strength. Removal of casing or screen sections requires only removal of the field weld at the top of the collar. Such sections are easily re-installed since the original faces of the tubes have not changed. Finally transportation and handling damage are reduced. The importance of having a field connection equal in strength to the casing or screen material cannot be overemphasized. Experience has demonstrated this frequently to unwary drilling contractors.

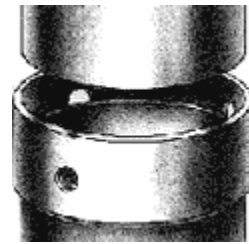

8.5 Stainless Steel to Carbon Steel Connections

Some concern has been expressed regarding the connection of stainless steel material to regular carbon steel in the field. A common thought is that galvanic action between the two dissimilar metals will cause the "less noble" carbon steel to deteriorate rapidly and fail. While galvanic action does take place initially, the carbon steel rusts and polarizes rapidly, effectively inhibiting further deterioration. If stainless steel is welded directly to carbon steel, the carbon steel section should be at least two times the thickness of the stainless section. A connection which may be used to eliminate welding two dissimilar metals is shown below.

Since threaded couplings are usually heavy, no difficulty results when stainless and carbon steel threaded connections are employed together.

- Slip mild steel ring A, with machined surface up over end of stainless steel joint
- Attach stainless steel ring D to top of stainless steel joint with chamfer on bottom.
- Assemble mild steel rings A,B, and C. B is an open ring. Clamp B around A and C making sure that A and C are snug against D. Tack weld in place.
- Seam weld B.
- Fellet weld B to A and C respectively

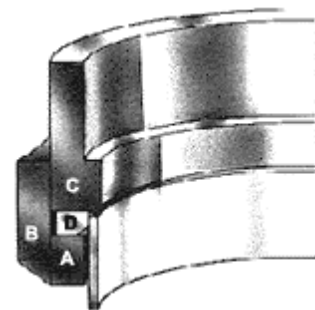

8.6 Compression Sections

In many arid and semi-arid regions of the world, a growing cause of well failure is the rupture of casing from subsidence of the ground because of depletion of water from the surrounding aquifer systems. Where the drop in artesian head greatly exceeds the water table decline, stresses are developed by the resulting hydraulic gradient that are often sufficient to cause one or more breaks in the well casing and screen. These breaks occur as the casing shortens by rupture. The broken sections usually divide into segments which slip past each other to produce a telescoping compression break. Experience has shown that such breaks and deformations cannot be prevented by employing stronger, heavier wall casing. Use of special telescoping joints, known as compression sections, installed in the casing and screen string, has solved this problem in many cases.

Compression sections are composed of three 6 foot lengths of casing, two of which are the same diameter and wall thickness as the well casing. These two joints are equipped with beveled steel rings welded to the lower end of the upper section and upper end of the lower section. Thus the joints are free to move or telescope within the length of an outer section of shell which is similarly equipped with rings at each end acting as stops and stabilizers. This shell is usually two inches larger than the parent casing. The rings are manufactured from $\frac{1}{2}$ x 2 inch steel and beveled to a 45° angle.

Location of compression sections should be given some study since compression failures have been known to occur in intervals between the joints. The user is advised to check the history of the area. Sections should be located at the depth or formation where breaks in surrounding wells have been obtained by locating a compression section at the bottom of the pump housing casing. If the well exceeds 1,500 feet in depth, another section may be placed in the middle of the screen string.

Clay is able to exert greater compressive force than coarser sediments, particularly in strata thicker than eight feet. This should also be considered when locating compression sections.

Despite the fact that in many areas surface levels have declined more than six feet, the six foot potential travel of the standard compression section has been found satisfactory.

8.7 Landing Clamps

When casing and screen is installed in an open hole to be gravel packed, it should be suspended from the surface by a heavy duty



Typical compression casing collapse

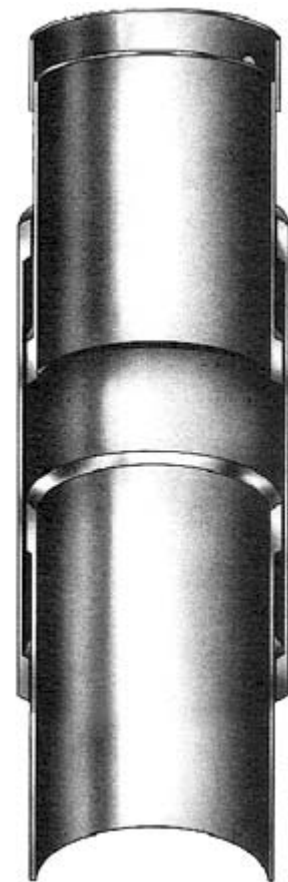

clamp. This clamp may be supported at the ground surface by beams, or it may rest on, or be notched into the surface protective casing. Surface protective casing, in turn, must be supported by beams or grouted in place. The purpose of suspending the casing and screen is to ensure that it remains straight and centered in the borehole. If a string rests on the bottom, it bows, preventing proper pack installation. The chart on the right shows a typical range of clamp sizes for various diameters and total casing and screen weights.

Chart Showing Clamp Size to Casing and Screen Weight.

Casing O.D.	A	B	C	D	E	F	G	H	Allowable Wt. Tons
6-5/8	5/8	6	22-9/16	8	1 1/16	4	3	7-7/8	18
	5/8	6	28-27/32	8	1 1/16	4	3	9-7/8	16
8-5/8	3/4	6	35-7/8	8	1 5/16	4	3	12-1/4	17
	3/4	8	35-7/8	8	1 5/16	4	5	12-1/4	31
10-3/4	3/4	6	42-5/32	8	1 5/16	4	3	14-1/4	16
	3/4	8	42-5/32	8	1 5/16	4	5	14-1/4	28
12-3/4	3/4	8	46-3/32	8	1 1/16	4	5	15-1/2	26
	1	8	46-25/32	8	1 1/16	4	5	16	35
14	3/4	8	46-25/32	8	1 1/16	4	5	16	26
	1	8	48-3/8	8	1 1/16	4	5	16-1/2	34
14-1/2	3/4	8	52-3/8	8	1 1/16	4	5	17-1/2	24
	1	8	53-1/16	8	1 1/16	4	5	18	32
16	1	10	53-1/16	8	1 1/16	6	3-1/2	18	50
	3/4	8	54-11/32	8	1 1/16	4	5	18-1/8	23
16-5/8	1	8	55-1/32	8	1 1/16	4	5	18-5/8	31
	1	10	55-1/32	8	1 1/16	6	3-1/2	18-5/8	49
18	3/4	12	58-21/32	8	1 1/16	6	4-1/2	19-1/2	50
	1	12	59-11/32	8	1 1/16	6	4-1/2	20	65
18-5/8	3/4	10	60-5/8	8	1 1/16	6	3-1/2	20-1/8	34
	1	10,12	61-5/16	8	1 1/16	6	3-1/2, 4-1/2	20-5/8	45, 65
20	3/4	10	65-1/8	8	1 1/16	6	3-1/2	21-1/2	32
	1	10,12	65-5/8	8	1 1/16	6	3-1/2, 4-1/2	22	43, 62
20-5/8	3/4	10	66-29/32	8	1 1/16	6	3-1/2	22-1/8	31
	1	10,12	67-19/32	8	1 1/16	6	3-1/2, 4-1/2	22-5/8	42, 60

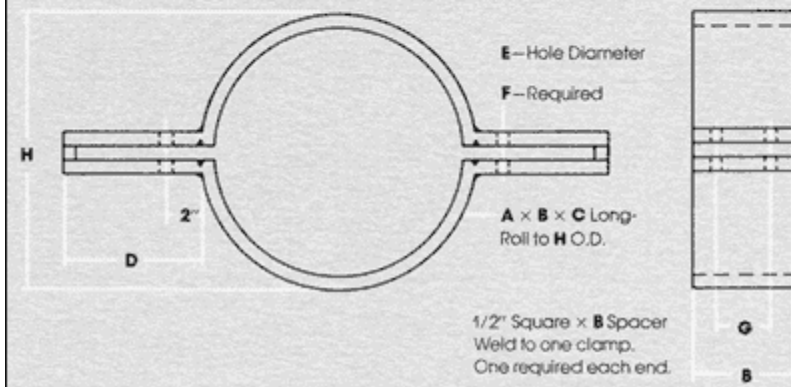

8.8 Casing Guides

Casing guides are used to center the screen within the borehole. They should be of sufficient strength and surface area to provide support, yet not impede the installation of gravel. These are conflicting requirements, and some compromise is required. A simple guide, which has proven effective, is manufactured from 5/16 x 2 inch steel, 30 inches long, bent to provide the proper centering distance. This distance or bend is usually the theoretical borehole radius minus the screen radius minus one inch. The guides are attached to the screen by welding. Three or four guides are placed equidistantly around the screen at 40 foot intervals. Normally, they are not installed on the upper or pump housing casing.



8.9 Float Plates

Float plates may be installed in casing strings, where the weight of the casing and screen exceed the safe lifting capacity of the installing rig. The plate, which must be manufactured from a frangible or breakable material, is installed between two joints of pump housing casing at a predetermined depth, where the collapsing strength of the casing is not exceeded and the rig is not overloaded. The weight of the casing is reduced by the weight of the fluid displaced. Cast iron plates of the design shown, machined to provide a watertight fit between the casing joints, have been found satisfactory.



The use of welding collars simplifies the installation of float plates considerably. To insure that hydrostatic forces on the empty casing above the float plate do not exceed its collapsing strength, the casing may be partially filled with water during installation as the buoyancy increases. Once the casing and screen is installed the upper pump housing casing is completely filled with water and the plate removed by striking with a bailer, drill pipe or tubing. Float plates must be used with great caution, and under no circumstances are as safe a procedure as direct installation with equipment of adequate weight bearing capacity.

8.10 Diameter Reductions

Occasionally reductions are made in diameter between casing and/or screen sections. Regular bell pipe reducers have been used, but they are expensive, and the reduction is rather abrupt. Reduction cones have been fabricated from pipe by torch-cutting segments from the pipe, bending the remaining segments inward, and welding the new seams together (orange peeling). This is a fairly expensive operation and results in a non-uniform, frequently weak structure. A better solution consists of the use of a fabricated tapered cone with a short stub joint of each diameter casing welded at each end. These stubs may be machined for greater alignment accuracy.

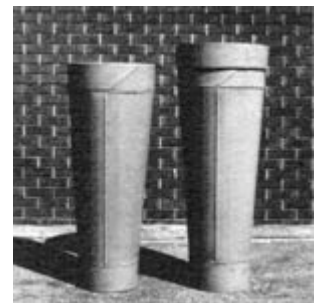

While no supporting data exists, it has been suggested that the length of the cone of the reducing section should be at least ten times the difference in diameter of the two ends for hydraulic efficiency and strength. It may be added that a longer tapered section or cone mitigates bridging at that point when gravel is introduced from the surface.

8.11 Bottom Plugs

A bull nose or plug is always attached to the bottom of casing and screen strings installed in gravel envelope wells. These may be fabricated by orange peeling a short joint of casing to a one to three foot taper, depending on diameter. Semi-elliptical tank ends, readily available and inexpensive, provide a convenient fulfillment of this requirement





9.0 APPENDICES AND TABLES

9.1 APPENDIX I

Well Efficiency

The concept of pumped well efficiency was first presented by Jacob in 1947. Basically, he defines "well efficiency" as the formation loss (the head loss required to produce flow) divided by the total drawdown observed in the well. This quotient is expressed as a percentage.

To the right is a simplified sketch illustrating this concept. Since ground-water flow through porous media is laminar in nature, the head loss required to produce the flow through the aquifer is proportional to the first power of the well discharge:

$$\text{Formation loss} = BQ$$

Where: B = formation loss coefficient.

The formation loss therefor is the difference between the static (non-pumping) water level and that water level observed in the aquifer (or gravel pack) adjacent to the casing or screen, (e.g. a small diameter piezometer placed in the gravel pack would measure only formation loss).

As the water enters the well bore through the screen openings, the velocity increases such that the flow becomes turbulent. The turbulence is caused by the "jetting" action through the well screen slots and the change in direction of the water as it enters laterally and is forced to move axially. The head loss associated with this turbulent flow is known as the well loss and varies as the second power of the discharge.

$$\text{Well loss} = CQ^2$$

Where: C = Well loss coefficient.

The formation loss coefficient then is related strictly to aquifer type, while the well loss coefficient is a function of well screen design and geometry (effective area of opening, type and

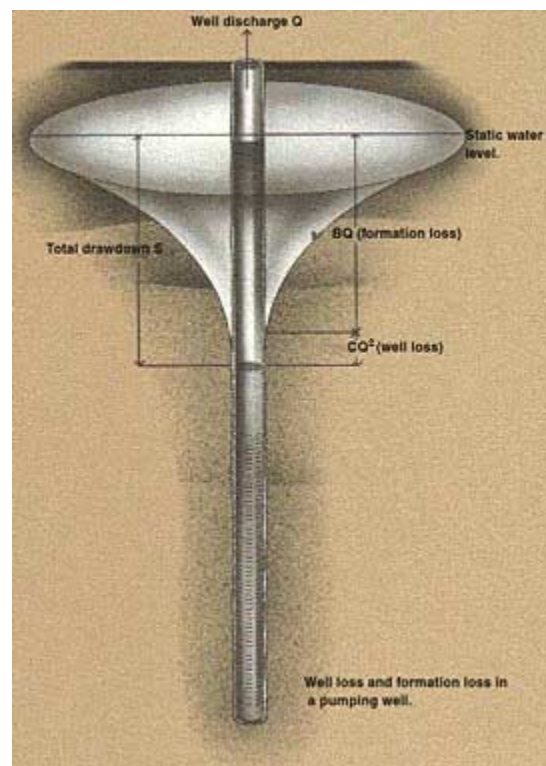

nature of slots or louvers). The total drawdown S observed in the well is simply the sum of the formation loss plus the well loss.

Total drawdown observed in well:

$$S=BQ + CQ^2$$

The pumped well efficiency is a measure of the effectiveness of the well screen as a transmitting medium between the aquifer (or gravel pack) and the well bore. This effectiveness (or well efficiency) is quantitatively expressed as:

Pumped Well Efficiency:

$$E = \frac{BQ}{BQ + CQ^2} \times 100$$

Rearranging the above equation results in:

Pumped Well Efficiency:

$$E = \frac{100}{1 + CQ/B}$$

As can be seen in the above equation, the well efficiency is not a constant but varies inversely with discharge (i.e. efficiency is maximum for low discharges and minimum for high discharges).

9.2 APPENDIX II

Formation Sampling, Filter Pack and Aperture Size Selection

Selection of filter pack gradation and the corresponding well screen aperture size are determined by mechanical analysis of the finest aquifer material to be screened. Methods of obtaining formation samples vary according to the type of drilling employed.

Rotary samples are subject to contamination by caving and commingling of dissimilar materials in the drilling fluid. In the direct rotary system a careful mud program will maintain the walls of the borehole, reduce caving and facilitate removal of cuttings. With proper location, design and construction of mud pits, recirculation of material can be controlled. In order to correlate samples with the hole depth, the driller should record the length of time for returns to appear with each change of formation. In the reverse rotary system, high return drilling fluid velocity reduces sampling lag time, and accurate samples are readily obtainable. More accurate sampling under both methods is provided when drilling is stopped at all formation changes and circulation continued until an adequate formation sample is obtained.

With direct rotary drilling, samples should be taken directly from the shaker or a sample box. With reverse circulation, they may be withdrawn from the discharge pipe through a 2-1/2 inch bypass fitted with a gate valve.

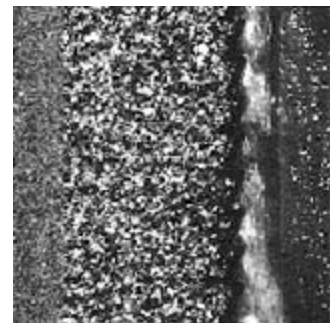

When drilling by the cable tool method, the principal tools utilized for taking formation samples are the bailer or mud scow. There is some tendency for the slurry produced by drilling to sort by grain size. Many drillers feel that the material found at the bottom of the first bailer is the most reliable. In unconsolidated alluvial formations, casing is carried more or less coincident with drilling, and samples are fairly representative of aquifer materials.

Unless otherwise required formation samples should be collected as follows:

1. At each ten foot interval below ground surface.
2. At each change of formation.
3. At each five foot interval within water bearing formations.

Divide the samples into three portions of approximately 1 pint each, and place them in suitable containers such as sample sacks, pint jars, or ziplock plastic bags. These are marked with well location, name or number of the well, depth interval represented by the sample and the date taken. One set is retained on the drill site for inspection, one delivered to the owner or his representative and the third retained for sieve analysis.

To prepare a sample for testing, remove the material from the container, place on a flat surface and mix thoroughly to assure that fine and coarse particles remain mixed. If the sample is wet, dry slowly over low heat, stirring frequently.

Coarse Sand and Gravel		Coarse to Medium Sand		Fine Sand	
U.S. Standard Sieve Number	Inch	U.S. Standard Sieve Number	Inch	U.S. Standard Sieve Number	Inch
4	.187	8	.093	20	.0331
6	.132	14	.0555	30	.0232
8	.093	20	.0331	50	.0117
12	.0661	30	.0232	80	.0070
20	.0331	50	.0117	100	.0059
50	.0117	80	.0070	200	.0029
Bottom Pan		Bottom Pan		Bottom Pan	

For analysis the coarsest sieve should retain 5 to 15% of the sample. Above are suggested sieve sized for three typical formation types.

Utilizing a selected set of sieves, arranged with the coarsest on top, the sample is placed on the top sieve and covered. The entire set is shaken until the material will no longer pass through the sieves (mechanical shaking preferred). Material retained on each sieve is removed, weighed and recorded. The cumulative percentage retained or passed is then calculated.

This data is transferred to a graph, such as shown on the following page, on which the cumulative percentage retained (or passed) on each screen (Y-axis) is plotted versus grain size (X-axis). Use of a semi-logarithmic scale for the X-axis gives a more realistic view of the importance of the finer particles. Points plotted are joined to form a curve. On the same graph plot a curve four times the formation size and one sixth times the formation size. The filter selected generally should lie between those lines.

With proper pack-aquifer ratios filtering takes place at the interface of the formation and envelope. Aperture size should permit a portion of the filter to pass. The percentage passing may vary somewhat without affecting results. Screen geometry is an important factor in establishing design criteria for particle retention. With mill cut slots 100% retention is often necessary to preclude plugging. However, this could result in an undesirably small opening. Ninety percent (90%) retention is recommended for wire-wrap screens. For shutter screens 65 to 80% retention is satisfactory although many wells have been completed with larger percentages passing when a more widely sorted filter pack is utilized.

While between four and six to one is the commonly accepted pack-aquifer ratio, wider latitude is possible. As low as three to one has been used without excessive headlosses through the pack. Conversely, ten to one has been employed without invasion of the gravel pack by formation material.

Filter quality is critically important. Material should consist of clean well rounded grains that are smooth and uniform. Neither crushed rock nor any natural material which presents an excess of 10% flat faces should be considered. Water flow is severely restricted even when flat particles are very large. The particles should be siliceous (quartz-like) with a limit of 5% by weight of calcareous material. Calcareous materials must be avoided since they tend to cement together, causing a severe reduction in envelope permeability.

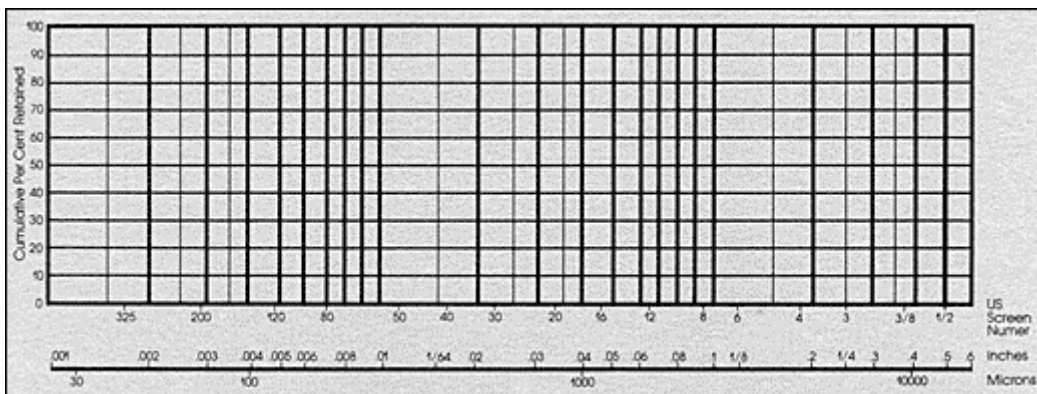

WATER WELL FILTER PACK AND FORMATION MECHANICAL GRADING ANALYSIS

The filter pack in a gravel envelope well serves two vital purposes. First, it acts as a stabilizer between the casing and screen and the borehole. The walls of the borehole are supported, preventing caving and sloughing which could damage the casing and screen or allow aquiclude materials (silts and clays) to block aquifers. Second, it provides a gradational filter for fine-grained particles in the aquifer. Neither purpose can be achieved if the filter material is not continuously and uniformly placed in the annulus.

For any filter pack selection based solely on formation sampling the following assumptions are made:

1. The formation samples are truly representative of the aquifer*.
2. The filter is installed in such a way that its gradation is uniform throughout.
3. The selected filter is available.

Since strict reliance on these assumptions has frequently been misleading, pack selection in well known areas generally draws heavily from field experience. While general standards are appropriate when based on successful past applications, they must still be verified in individual cases by formation sampling and analysis.

*The most common sampling error with rotary construction methods is undercollecting fine materials.

9.3 APPENDIX III

Analysis of Driving Casing with Cable Tool Equipment

Unfortunately water well drilling history is filled with examples of casing that has failed under the stress on installation by driving. Driving is accomplished through the impact of the weight of the drilling tools on the casing. The top of the casing is equipped with a drive head which acts as an anvil. Clamps are attached to the tool string to serve as a hammer face. Blows may be struck singly through raising or dropping the tool string under the control of the operator, or repeatedly by using the motion of the walking beam.

Since friction restraining the casing usually originates at the bottom or shoe, it appears as though driving would not create stresses that would cause the casing to separate, either in the parent tube or at the joints. Observation suggests that driving forces are compressive forces which would tend to hold the casing together. This is not the case, however, and an analysis of what actually occurs to a casing string under these stresses may help to avoid operating conditions which cause failure.

When a casing that is free at both ends is struck at one end, a compressive pulse travels downward. As this pulse travels, it sets in motion the particles at any point in its travel. This motion continues in the direction of the pulse. When the pulse reaches the end of the casing (shoe), it returns in the opposite direction, but changes to a tensile or pulling apart force rather than a compressive one. This process is repeated until the pulses are dampened by formation material surrounding the casing.

Ultra high speed photography has provided a visual demonstration of the foregoing. When casing is struck, it initially displays a start-stop behavior. After a pause equivalent to the time for the wave to travel down and up the casing, the casing drops. In one observation in Pasadena, California, five drops occurred, becoming smaller and smaller before finally dampening out. These drops occurred over a period of one-fifth second.

Since much of the force involved in casing driving is tensile, considerable care must be taken with respect to the quality of joints, particularly under heavy driving conditions. If joints are welded, discontinuities, undercuts or notches should be avoided since repeated driving may result in fatigue failure at such points.

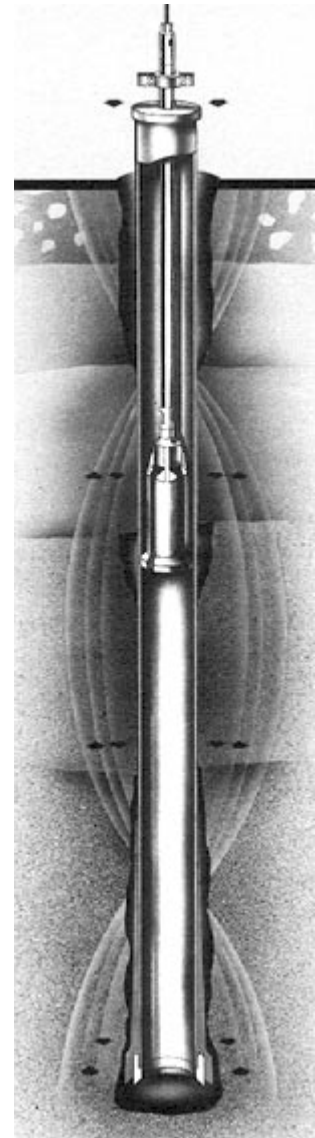

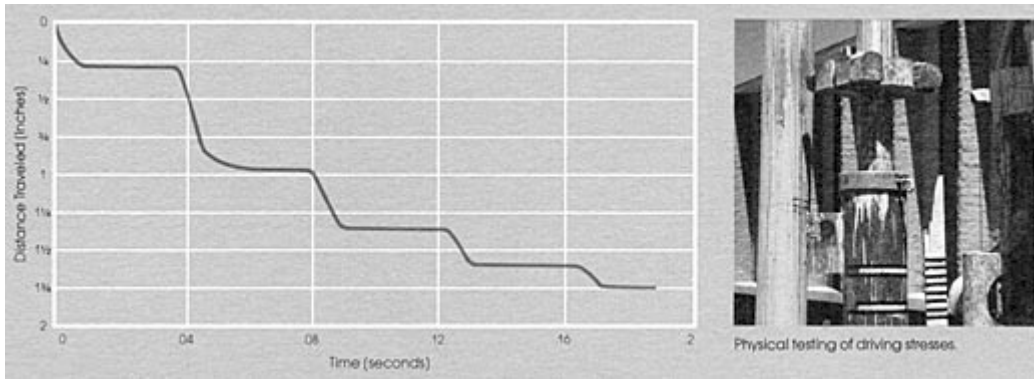

Graph Illustrating Downward Casing Movement In 5 Successive Drops Following One Driving Impact

The number of blows a well as their individual impact force are critical factors in casing or joint failure. Of the two, impact forces are more important. If there is any concern, smaller impact forces (lighter driving) is recommended, even if it takes more blows to install the casing.

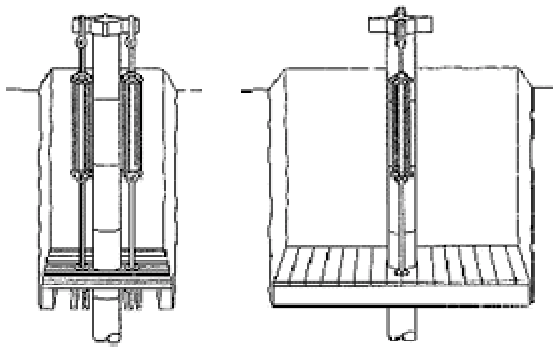

One situation which requires extra caution occurs when driving casing where the shoe is free, but the casing is tightly enclosed further up the hole. There is a tendency for stress forces to concentrate below the point of casing restraint. Numerous instances of casing as well as joint failure at such locations have been recorded.

The ability of casing to resist deformation at the point of driving impact is proportional to its thickness and the yield point of the metal. Higher strength grades are more effective under stress of this nature.

An early interesting innovation in water well construction was the development of a specialized casing which overcame the aforementioned problems, as well as the tendency of casing to freeze in unconsolidated alluvial materials, preventing installation. This casing, known as double well casing, originated in the South-western United States in the late 19Th century, and with modifications is still in use today.

Double well casing is manufactured from high tensile steel in four foot inside and outside joints. The joints are tight fitting, and are offset so that the juncture of outside joints occurs at the center of an inside joint and vice versa. Strength and durability are derived from inherent structural qualities rather than from welded joints, which are subject to imperfection.

(Cross section double well casing)

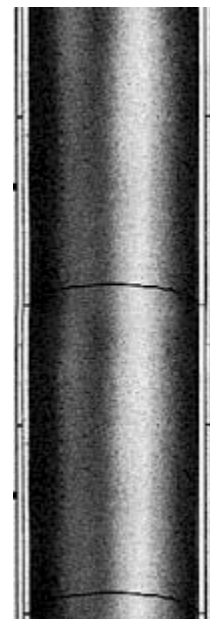

Double well casing is produced in four foot lengths since installation through the use of four foot stroke jacks was found convenient. For driving purposes, individual lengths may be assembled into longer sections. In either case, the smooth interior permits free passage of drilling tools and the smooth exterior minimizes friction during installation. 20 inch cased wells have been carried to depths of over 2,000 feet with this material.

9.4 APPENDIX IV

Water Sampling for Chemical Analysis

If possible, obtain sample bottles and directions for taking samples from the laboratory. Make arrangements to coordinate the collection, transportation, and testing of the samples so as to minimize delay in testing for pH, bacteria, and other constituents where time of standing may affect results.

When taking bacteriological samples, the bottle must be sterile and care must be exercised not to contaminate either the bottle or sample. Allow the sample tap to flow smoothly for at least one (1) minute before collecting sample. Do not flush at high rate first since this will disturb sediment in the sample pipe. Avoid touching the inside of the bottle cap or the lip of the bottle.

Samples for mineral analysis must be taken in clean bottles with plastic (non-metal) caps. Allow only enough air space for thermal expansion so as to minimize gain or loss of carbon dioxide. Avoid splashing or entraining air bubbles during collection.

When collecting samples from wells, temperature should always be taken, because this may provide a clue as to the average depth of the producing aquifers. The thermometer should have the scale engraved on the glass and the graduations should be such that you can estimate the reading to the nearest degree F. Allow the water to overflow a small plastic container (a polystyrene coffee cup is ideal). Immerse the thermometer in the cup and read the temperature after the reading has been constant for a minute or more.

Samples for dissolved oxygen are not difficult to take, but you must have the following equipment and reagents:

1. A ¼" O.D. polyethene tube that can be connected to the sample tap.
2. A special sample bottle with a tapered ground-glass stopper. It should have a capacity of approximately 250ml.
3. Three small (35 to 100ml) bottles equipped with screw-on rubber bulb dispensing pipettes. The pipettes should discharge approximately 0.5ml when the bulb is squeezed (an ordinary eye dropper is satisfactory).
 - a. The first bottle contains a 40% solution of manganous sulfate $MnSO_4 \cdot 2H_2O$.
 - b. The second bottle contains alkaline iodine reagent consisting of 70gm of KOH and 150gm KI diluted to 100ml.
 - c. The third bottle contains concentrated sulfuric acid. This is one of the most dangerous chemicals in common use and must be handled with great care.

Fill the sample bottle with water, using the plastic tube immersed almost to the bottom of the special bottle. Allow it to overflow so that 4 to 10 volumes have been displaced. Turn off the sample tap and withdraw the plastic tube, being careful to avoid introducing any air in the sample. Immerse the ever dropper containing the manganous sulfate under the surface of the water and add one ml (two squirts) of manganese sulfate reagent. Next add one ml of alkaline iodide reagent, taking pains to assure that no air bubbles are introduced when the reagent is added. Insert the stopper without trapping any air bubbles and mix the solution by rapidly inverting the bottle. A heavy floc of manganese hydroxide will form at this point. Allow this floc to settle for three (3) or four (4) minutes, remove the stopper carefully, add one ml of concentrated sulfuric acid. Again insert the stopper and mix by inverting the bottle.

The sample now contains a solution of iodine that is chemically equivalent to the initial dissolved oxygen. The solution is stable and can be transported to the laboratory for exact determination.

9.5 TABLE A

Head Losses Through Pipe

Lay a straightedge on scales at the points for any two known quantities, and the unknown quantities will lie at intersection of the straight edge with the other scales.

Example: To discharge 500 gallons per minute through 6-inch pipe, following **dotted line** would show loss of head in a thousand feet of approximately 25 feet and velocity of 5.7 feet per second.

Note: Loss of head in cast iron pipe = loss of head in steel pipe multiplied by 1.5. Loss of head in concrete pipe = loss of head in steel pipe multiplied by 2. When pipe is somewhat rough add 10 percent to loss of head; when very rough add 25 percent.

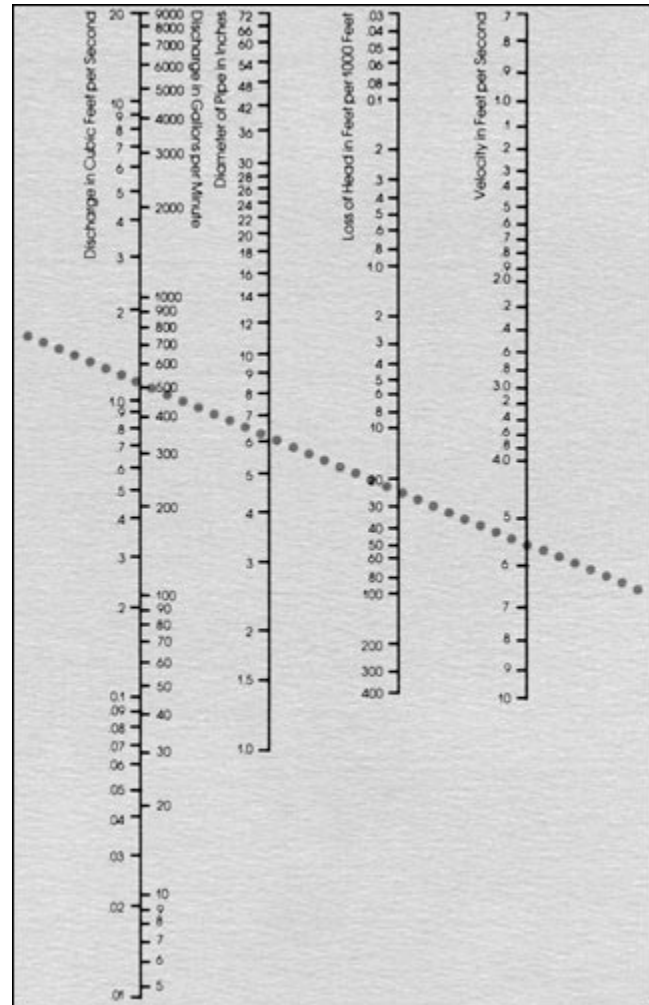

9.6 TABLE B

Physical Characteristics Blank Casing

c	Inside Diameter		Wall Thickness		Weight		Collapsing Strength				Axial Compression Strength		Tensile Strength		
	Inches	mm	Inches	mm	Inches	mm	lbs/ft	kg/mt	PSI	ft/water	Kg/cm ²	m/water	Tons	KG	Tons
6.625	168	6.406	163	.1094	2.77	7.61	11.33	1.99	459	13.9	139	39.2	35,552	67.7	60,946
6.625	168	6.344	161	.1406	3.57	9.74	14.45	371	857	26.1	261	50.1	45,471	85.9	77,952
6.625	168	6.281	159	.1719	4.36	11.85	17.63	593	1369	41.7	417	61.0	55,326	104.5	94,845
6.625	168	6.250	158	.1875	4.76	12.81	19.08	720	1662	50.6	506	66.4	60,192	113.7	103,147
6.625	168	6.125	156	.250	6.35	17.02	25.35	1288	2974	90.5	905	87.6	79,442	150.1	136,196
8.625	219	8.406	213	.1094	2.77	9.95	14.80	99	229	7.0	70	51.2	46,464	87.8	79,653
8.625	219	8.344	212	.1406	3.57	12.74	18.96	192	444	13.5	165	65.6	59,497	112.4	101,995
8.625	219	8.281	210	.1719	4.36	15.52	23.09	319	736	22.4	224	79.9	72,474	137.0	124,241
8.625	219	8.250	208	.1875	4.76	16.79	25.01	393	908	27.7	277	87.0	78,905	149.1	135,265
8.625	219	8.125	206	.2500	6.35	22.36	33.30	756	1745	53.2	532	115.1	104,427	197.3	179,018
10.750	273	10.375	264	.1875	4.76	21.15	31.47	228	528	16.1	161	108.9	98,777	186.37	169,332
10.750	273	10.250	260	.2500	6.35	28.04	41.72	461	1065	32.5	325	144.3	130,923	247.4	224,440
10.750	273	10.125	257	.3125	7.94	34.71	51.70	760	1756	53.5	535	179.3	162,680	307.4	278,880
12.750	324	12.375	314	.1875	4.76	25.16	37.44	147	340	10.4	104	129.5	117,480	222.0	201,395
12.750	324	12.250	311	.2500	6.35	33.38	49.67	306	707	21.6	216	171.8	155,861	294.5	267,191
12.750	324	12.125	308	.3125	7.94	41.52	61.78	521	1203	36.7	367	213.7	193,852	366.3	322,318
12.750	324	12.00	305	.3750	9.53	49.57	73.84	795	1835	55.9	559	262.4	238,067	437.4	396,778
14.000	356	13.625	346	.1875	4.76	27.73	41.16	115	265	8.1	81	142.4	129,170	244.1	221,434
14.000	356	13.500	343	.2500	6.35	36.71	54.63	242	560	17.1	171	189.0	171,447	324.0	293,910
14.000	356	13.375	340	.3125	7.94	45.68	67.98	419	967	29.5	295	235.2	213,335	403.1	365,717
14.000	356	13.250	337	.3750	9.53	54.57	81.21	636	1469	44.8	448	280.9	254,833	481.6	436,857
14.500	368	14.125	359	.1875	4.76	28.66	42.65	105	242	7.4	74	147.5	133,846	252.9	229,450
14.500	368	14.00	356	.2500	6.35	38.05	56.62	222	512	15.6	156	195.9	177,682	335.8	304,597
14.500	368	13.875	352	.3125	7.94	47.36	70.47	385	890	27.1	271	243.8	221,128	417.9	379,077
14.500	368	13.750	349	.3750	9.53	56.57	84.12	588	1359	41.4	414	291.2	264,195	499.2	452,888
16.000	406	15.625	397	.1875	4.76	31.67	47.12	80	185	5.6	56	163.0	147,873	279.4	253,497
16.000	406	15.500	394	.2500	6.35	42.05	62.58	172	398	12.1	121	216.5	196,385	371.1	336,660
16.000	406	15.375	391	.3125	7.94	52.36	77.92	303	700	21.3	213	269.5	244,507	462.0	419,155
16.000	406	15.250	387	.3750	9.53	56.57	84.12	588	1359	41.4	414	291.2	264,195	499.2	452,888
16.625	422	16.250	413	.1875	4.76	32.29	46.05	72	167	5.1	51	169.4	153,718	290.5	263,517
16.625	422	16.125	410	.2500	6.35	43.73	65.07	156	360	11.0	110	225.1	204,178	385.8	350,020
16.628	422	16.000	406	.3125	7.94	54.45	81.02	276	637	19.4	194	280.3	254,249	480.4	435,854
16.625	422	15.875	403	.3750	9.53	65.09	96.96	429	991	30.2	302	335.0	303,929	574.3	521,022
18.000	457	17.625	448	.1875	4.76	35.67	53.08	58	134	4.1	41	183.6	166,577	314.8	285,560
18.000	457	17.500	445	.2500	6.35	47.39	70.53	126	292	8.9	89	244.0	221,323	418.2	279,411
18.000	457	17.375	441	.3125	7.94	59.03	87.85	226	521	15.9	159	303.9	275,680	520.9	472,594

18.000	457	17.250	438	.3750	9.53	70.59	105.05	355	820	25.0	250	363.4	329,647	622.9	565,108
18.625	473	18.250	464	.1875	4.76	36.92	54.94	53	122	3.7	37	190.1	172,422	325.8	295,580
18.625	473	18.125	460	.2500	6.35	49.07	73.02	116	267	8.1	81	252.6	229,116	433.0	392,770
18.625	473	18.000	457	.3125	7.94	61.33	91.26	207	478	14.6	146	314.6	285,421	539.4	289,294
18.625	473	17.875	454	.3750	9.53	73.10	108.89	327	755	23.0	230	376.3	341,336	645.0	585,148
20.000	508	19.625	498	.1875	4.76	39.68	59.04	43	100	3.1	31	204.2	185,280	350.1	317,623
20.000	508	19.500	495	.2500	6.35	52.73	78.48	95	221	6.7	67	271.5	246,261	465.4	422,161
20.000	508	19.375	492	.3125	7.94	65.71	94.79	172	398	12.1	121	338.2	306,852	579.8	526,032
20.000	508	19.250	489	.3750	9.53	78.60	116.97	274	633	19.3	193	404.6	367,053	693.6	629,234
20.625	524	20.250	514	.1875	4.76	40.93	60.90	40	92	2.8	28	210.7	191,125	361.2	327,643
20.625	524	20.125	511	.2500	6.35	54.41	80.96	88	203	6.2	62	280.0	254,054	480.1	435,551
20.625	524	20.000	508	.3125	7.94	67.80	100.09	159	367	11.2	112	349.0	316,593	598.3	542,731
20.625	524	19.875	505	.3750	9.53	81.11	120.82	254	586	17.9	179	417.5	378,743	715.7	649,273

9.6 TABLE C

Specifications Steel Pipe

SPECIFICATION	TITLE	METHOD OF MANUFACTURE	END USE	GRADE	YIELD (MIN PSI)	TENSILE (MIN PSI)	CARBON (%)	MANGANESE (%)	COPPER (%)	RESISTANCE TO ATMOSPHERIC CORROSION
API 5L*	API Specification for line pipe	ERW and Seamless	Line Pipe	Grade A Grade B	30,000 35,000	48,000 60,000			Residual	Carbon Steel
AWWA C 200**	Standard for Steel Water Pipe 6" and larger	All	Water Pipe	Grade A Grade B Other Grade as specified by customer	To ASTM steel raw material standard	To ASTM steel raw material standard	To ASTM steel raw material standard	To ASTM steel raw material standard	Residual Residual Residual unless so specified	Carbon Steel Carbon Steel If Copper is specified 2 X Carbon Steel
ASTM A 53***	Pipe, Steel, Black and Hot - Dipped, Zinc - Coated Welded and Seamless, 1/8TH - 26"	CW, ERW and Seamless	Suitable for forming, bending, and coiling	Grade A Grade B	30,000 35,000	48,000 60,000	.25 max .30 max	.95 max 1.20 max	Residual	Carbon Steel
ASTM A 120	Pipe, Steel Black and Hot - Dipped, Zinc-Coated (Galvanized) Welded and Seamless, for Ordinary Uses.	CW, ERW and Seamless	Line Pipe						Residual	Carbon Steel
ASTM A 134	Pipe, Steel, Electric-Fusion (Arc)-Welded, 16" and over	Fabricated, Press Formed or Spiral	Line Pipe and various	According to ASTM A 283,285,570,36 or other ASTM raw Material As Specified	As Specified	As Specified	As Specified	As Specified	Residual unless specified	If Copper is Specified 2 X Carbon Steel
ASTM A 135	Electric-Resistance Welded Steel Pipe	ERW	Line Pipe	Grade A Grade B	30,000 35,000	48,000 60,000	.25 max .30 max	.95 max 1.20 max	Residual	Carbon Steel

ASTM A 139	Electric-Fusion (Arc) - Welded, Steel pipe (sizes 4" and over)	SAW Straight Seam or Spiral	Line Pipe and various	Grade A Grade B Grade C Grade D Grade E	30,000 35,000 42,000 46,000 52,000	48,000 60,000 60,000 60,000 66,000	----- .30 max .30 max .30 max .30 max	1.00 max 1.00 max 1.20 max 1.30 max 1.40 max	Residual unless specified	If Copper is Specified 2 X Carbon Steel
ASTM A 211	Spiral-Welded Steel or Iron Pipe	Spiral	Line Pipe and various	According to ASTM A 570 Or otherwise Specified	As specified	As specified	As specified	As specified	Residual unless specified under Table 1 of ASTM A 570	If Copper is Specified 2 X Carbon Steel
ASTM A 252	Welded and Seamless Steel Pipe Piles	Seamless, ERW, SAW Straight Seam or Spiral	Pipe Piles	Grade 1 Grade 2 Grade 3	30,000 35,000 45,000	50,000 60,000 66,000			Residual	Carbon Steel
ASTM A 409	Welded Large Diameter Austenitic Steel Pipe for Corrosive or High Temperature Service 14" - 30"	SAW Straight Seam or Spiral	Corrosive or High Temperature Service	10 Grades of Chromium Nickle Stainless Steel are covered by this specification including types 304 and 316	As Specified according to grade	As Specified according to grade	As Specified according to grade	As Specified according to grade	As Specified according to grade	Corrosion rate is nil
ASTM A 714	High Strength Low Alloy Welded and Seamless Steel Pipe ½"-26"	CW, ERW and Seamless	General Purposes where saving in weight or added durability are important	Class 2 Class 4	50,000 36,000 to 50,000 depending on grade (8)	According to grade	According to grade	According to grade	.20% min .20% min	2 X Carbon Steel 4 X Carbon Steel
ASTM A 778	Welded, Unannealed Austenitic Stainless Steel Tubular Products	Any Method Incorporating a Shielded Arc Welding Process Such as SAW or TIG	Corrosive Service	5 Grades of Chromium	Nickle Stainless Steel are covered by this Specification Including types 304L and 316L.	As Specified according to grade	As Specified according to grade	As Specified according to grade	As Specified according to grade	Corrosion rate is nil

Shown above are frequently used specifications for steel pipe, their method of manufacture, end use, strength requirements of the finished product and chemistry as applicable. Titles and grades have been abbreviated in some cases for clarity.

* American Petroleum Institute

** American Water Works Association

*** American Society for Testing and Materials

9.8 TABLE D

Specifications Steel

SPECIFICATION	TITLE	GRADE	YIELD (Min PSI)	TENSILE (Min PSI)	CARBON (%)	MANGANESE (%)	COPPER (%)	RESISTANCE TO ATMOSPHERIC CORROSION
ASTM A 36	Structural Steel (Plates)		36,000	58,000	25 max		.20 min if specified under Table 2 of ASTM A 36	If copper is specified 2 X carbon steel
ASTM A 167	Stainless Chromium-Nickel Steel Plate, Sheet and Strip	20 Grades of Chromium-Nickel Stainless Steel are Covered by this specification Including types 304 and 316.	According to grade. The yield and tensile strengths of types 304 and 316 are 30,000 PSI and 75,000 PSI.					Corrosion rate is nil
ASTM A 242	High-Strength, Low Alloy Structural Steel (Plates)		50,000	70,000	Alloying elements to provide required strength and corrosion resistance vary from manufacturer to manufacturer.		.20 minimum	4 X Carbon Steel
ASTM A 283	Low and Intermediate Tensile Strength, Carbon Steel Plates, Shapes, and Bars	A B C D	24,000 27,000 30,000 33,000	45,000-55,000 50,000-60,000 55,000-65,000 60,000-72,000			.20% min if specified under table 2 of ASTM A 283	If copper is specified 2 X carbon steel
ASTM A 569	Steel, Carbon (0.15 max. Percent), Hot-Rolled Sheet And Strip, Commercial Quality				.15 max	.60 max	.20% min. if specified under table 1 of ASTM A 569	If copper is specified 2 X carbon steel

ASTM A 570	Hot-Rolled	30	30,000	49,000	.25 max	.90 max	.20% min. if specified under table 1 of ASTM A 570	If copper is specified 2 X carbon steel
	Carbon Steel	33	33,000	52,000	.25 max	.90 max		
	Sheet	36	36,000	53,000	.25 max	.90 max		
	And Strip,	40	40,000	55,000	.25 max	.90 max		
	Structural	45	45,000	60,000	.25 max	1.35 max		
Quality	50	50,000	65,000	.25 max	1.35 max			
ASTM A 606	Steel Sheet and Strip, Hot-Rolled and Cold-Rolled, High-Strength Low-Alloy, With Improved Corrosion Resistance	Type 2 Type 4	50,000	70,000	.22 max	1.25 max	Alloying elements vary from manufacturer to manufacturer but must produce strength and corrosion resistance for each type as specified.	2 X Carbon Steel 4 X Carbon Steel
ASTM A 635	Hot-Rolled Carbon Steel Sheet and Strip, Commercial Quality Heavy-Thickness Coils (Formerly Plate)	15 Grades			Carbon ranges from .08 max to .25 max and manganese from .45 max to 1.65 max according to grade.		.20% min if specified under table 1 of ASTM A 635	If Copper is specified 2 X carbon steel

Shown above are specifications associated with steel pipe and water well casing manufacture, their strength requirements, and chemistry as applicable. Titles and grades have been abbreviated in some cases for clarity.

While many pipe specifications cite manufacture from some of these raw material specifications others do not, relying on testing of the finished pipe to assure compliance with physical requirements. In such cases the manufacturer may order raw material according to one of the specifications above, another standard as agreed, or to a steel chemistry which taking in consideration physical changes occurring in the manufacturing process results in the desired product.

The differences between plate, sheet and strip are dimensional but are related to some extent to the mill process used to manufacture the product from the slab stage. This causes some confusion since pipe is manufactured from all three categories. ASTM A 635, a specification frequently used by manufacturers of ERW and spiral seam pipe, covers coils with plate thickness.

9.9 TABLE E

Conversion Table

Atmosphere	=	33.94 feet of water
Atmosphere	=	29.92 inches of mercury
Atmosphere	=	760 mm of mercury
Atmosphere	=	14.70 lbs per square inch
Barrel	=	5.6146 cubic feet
Barrel	=	42 gallons
Centimeter	=	0.3937 inch
Cubic Centimeter	=	0.06102 cubic inch
Square Centimeter	=	0.1550 square inch
Gallon (US)	=	0.1337 cubic feet
Gallon (US)	=	231 cubic inches
Gallon (US)	=	0.8327 gallon (Imperial)
Gallon (US)	=	3.785 liters
Gallon per Minute (GPM)	=	227.10 liters/hour
Gallon per Minute (GPM)	=	0.063 liters/second
Gallon per Minute (GPM)	=	34.2860 barrels per day
Horse Power	=	0.7457 kilowatts
Meter	=	3.2841 feet
Meter	=	39.37 inches
Cubic Meter	=	264.17 gallons (US)
Foot	=	0.3048 meter
Foot	=	30.48 centimeters
Cubic Foot	=	28.317 cubic centimeters
Cubic Foot	=	7.4805 gallons (US)
Cubic Foot	=	0.02832 cubic meter
Square Foot	=	929.03 square centimeters
Inch	=	2.54 centimeters
Cubic Inch	=	16.39 cubic centimeters
Square Inch	=	6.452 square centimeters
Inch of Mercury (60°F)	=	0.361 lbs/per square inch
Liter	=	0.2642 gallons
Liters/second	=	15.85 gallons per minute
Liters/hour	=	0.0044 gallons per minute

Cubic Meter	=	35.314 cubic feet
Square Meter	=	10.76 square feet
Ounce (Avoirdupois)	=	28.3495 grams
Pound	=	0.4536 kilogram
Pounds per Square Inch	=	0.703 kilograms per square cm
Pounds per Square Inch	=	2.309 feet of water (60°F)
Temperature (Cent.)	=	$5/9$ (temp. Fahrenheit - 32)
Temperature (Far.)	=	$9/5$ (temp. Centigrade +32)
Tan (long)	=	2,240 pounds
Ton (metric)	=	1,000 kilograms
Ton (metric)	=	2,205 pounds
Ton (metric)	=	1.102 short ton